

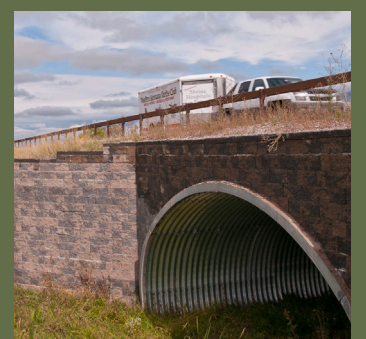

Cost effective solutions: Animal vehicle collision reduction and habitat connectivity *- Final Report*

NDOT Research Report

No. 701-18-803 TO 1 Part 4



Wildlife Vehicle Collision Reduction and Habitat Connectivity Pooled Fund Study, TPF-5(358)

REDUCE
Wildlife Vehicle Collisions

INCREASE
Habitat Connectivity

IMPLEMENT
Cost Effective Solutions



COVER PHOTO CREDITS

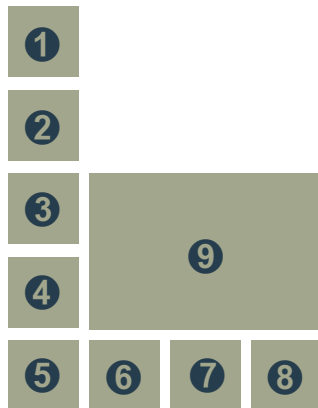

- ❶ N. Hetherington, WTI/MSU
- ❷ Adobe Stock
- ❸ Elizabeth Fairbank, CLLC
- ❹ Maierpa, Wikipedia
- ❺ N. Hetherington, WTI/MSU
- ❻ N. Hetherington, WTI/MSU
- ❼ Matthew Bell, WTI/MSU
- ❽ N. Hetherington, WTI/MSU
- ❾ N. Hetherington, WTI/MSU

SUGGESTED CITATION

Ament R, Huijser M, May D. Cost effective solutions:
Animal vehicle collision reduction and habitat connectivity
- Final Report. Transportation Pooled Fund Study, TPF-5(358).
Nevada Department of Transportation, Carson City, NV.

DOI

10.15788/ndot2022.1.4

PROJECT INFORMATION

View more projects and reports generated by TPF-5(358), please visit
<http://tpf-5-358-wvc-study.org>

Animal Vehicle Collision Reduction and Habitat Connectivity Cost Effective Solutions

Final Report

Edited by

Marcel Huijser, Dana May, Robert Ament

WTI Research Team Authors

Robert Ament, Matthew Bell, Cheryl Brehme, Anthony Clevenger, John Duffield, Elizabeth Fairbank, Damon Fick, Robert Fisher, Adam Ford, Kari Gunson, Terry McGuire, Chris Neher, Kylie Paul

USGS Contributing Authors

S. Barnes, B. Ewing, P. Gould, M. Hobbs, S. Holm, H. Sheldon, J.A. Tracey, C. Tornaci, C. Vaughan

Prepared by

Western Transportation Institute (WTI)
College of Engineering
Montana State University
Bozeman, MT



Prepared for

Nevada Department of Transportation
1263 South Stewart Street
Carson City, NV 89712



Disclaimer

This is report submitted by the Contractor. The opinions and conclusions expressed or implied herein are those of the Contractor. They are not necessarily those of the Nevada Department of Transportation or other Pooled Fund sponsors.

September 30, 2022

Wildlife Vehicle Collision Reduction and Habitat Connectivity Pooled Fund Study, TPF-5(358)

REDUCE

Wildlife Vehicle Collisions

INCREASE

Habitat Connectivity

IMPLEMENT

Cost Effective Solutions



ACKNOWLEDGMENTS

ADMINISTRATING TPF PARTNER: NEVADA DEPARTMENT OF TRANSPORTATION

We would like to thank the Nevada Department of Transportation (NDOT) and its many staff members for contributing to the administration of this pooled fund study. In particular, Ken Chambers and Nova Simpson, who were supportive of this entire enterprise and provided it leadership from start to finish.

CONTRIBUTING TPF PARTNERS

We are appreciative of the many agencies from both the US and Canada who joined together and worked seamlessly on this international pooled fund study. Another inspiration was the non-profit ARC Solutions. Such broad interest in this project and its many subjects of inquiry bodes well for future implementation of its results.

- Alaska DOT and Public Facilities
- ARC Solutions, Inc.
- Arizona DOT
- California DOT
- Iowa DOT
- Michigan DOT
- Minnesota DOT
- New Mexico DOT
- Ontario Ministry of Transportation
- Oregon DOT
- Parks Canada Agency
- Washington DOT
- In cooperation with the US Department of Transportation, Federal Highway Administration.

TECHNICAL ADVISORY COMMITTEE

We want to thank all the members of the Technical Advisory Committee (TAC) who shared their knowledge, information, time, and talent for the duration of the project. And especially for the hundreds and hundreds of pages of draft reports that were reviewed and commented upon to make them so much better: Cidney Bowman - Oregon DOT, Steve Gent - Iowa DOT, Cathy Giesbrecht - Ontario Ministry of Transportation, Jeremy Guth – Arc Solutions, Matt Haverland - New Mexico DOT, Sandra Jacobson - ARC Solutions, Glen Kalisz - Washington DOT, Trevor Kinley - Parks Canada, Jon Knowles - Alaska Department of Transportation and Public Facilities, Melinda Molnar – Caltrans, Amanda Novak - Michigan DOT, Larry Sarris - Ontario Ministry of Transportation, Chris Smith – MnDOT, and Justin White - AZDOT

GRAPHIC AND WEB DESIGN

Neil Hetherington, WTI



Table of Contents

| | |
|---|------------|
| Acknowledgments | 4 |
| Executive Summary | 6 |
| Introduction | 9 |
| TPF Study Overview | .11 |
| Literature Review Of Mitigation Measures | .14 |
| Economics | .18 |
| Incorporating Wildlife Passive Use Values in Collision Mitigation Benefit-Cost Calculations | 18 |
| Incorporating Deer and Turtle Total Value in Collision Mitigation Benefit-Cost Calculations | 21 |
| Update and Expansion of the WVC Mitigation Measures and Their Cost-Benefit Model | 23 |
| Ecology | .28 |
| A Comparison of Elk-Vehicle Collisions Patterns with Demographic and Abundance Data in the Central Canadian Rocky Mountains | 28 |
| Long-Term Responses of an Ecological Community to Highway Mitigation Measures | 31 |
| A before-after-control-impact study of wildlife fencing along a highway in the Canadian Rocky Mountains | 32 |
| Electrified Wildlife Barriers at Fence Ends and at Access Roads | 34 |
| Design | .35 |
| Fiber-Reinforced Polymer Wildlife Crossing Infrastructure | 35 |
| Research to Inform Passage Spacing for Migratory Amphibians and to Evaluate Efficacy and Designs for Elevated Road Segment (ERS) Passages | 40 |
| Modified Jump-Outs for White-Tailed Deer and Mule Deer | 42 |
| Internal Structural Cover and Ledges Facilitate the Use of Large Underpasses for Multiple Wildlife Species and Groups | 44 |
| Best Practices | .46 |
| Best Practices Manual to Reduce Animal-Vehicle Collisions and Provide Habitat Connectivity for Wildlife | 46 |
| Conclusions | .50 |
| References | .52 |
| List of Figures | .54 |
| List Of Tables | .56 |



EXECUTIVE SUMMARY

Wildlife-vehicle collisions (WVCs) are significant component of overall crashes in the US and Canada, and local populations of wildlife, both large and small, have suffered restrictions to their safe movement across roads. While there are several proven mitigation measures that significantly reduce WVCs, provide safe wildlife passage, and maintain habitat connectivity, there are many new technologies and improvements to existing effective mitigation measures that may help reduce mitigation costs. For example, established infrastructure measures such as overpasses and underpasses with fencing can reduce large animal WVCs by 83% on average; yet these projects can be costly and don't always consider the many crashes that involve smaller animal species, such as reptiles and amphibians. Thus, there is room for improvement, additional study, and evaluation of various existing and promising mitigation measures.

This Transportation Pooled Fund Study, TPF-5(358) (TPF Study), allowed researchers to evaluate the latest information on the effectiveness of 24 different highway mitigation measures designed to decrease collisions with large wildlife, large feral and domestic animals, and small mammals, reptiles, and amphibians. It also explored the effectiveness of these same measures to enhance habitat connectivity. Through a literature review, eleven research projects, and a best practices training manual, four broad themes were addressed: economics, ecology, design, and practice.

LITERATURE REVIEW

The Literature Review examined 24 mitigation measures. Ten of these measures were found to achieve at least a 50% reduction in animal-vehicle collisions (AVCs – wildlife and domestic/feral animals), but only three were found to be highly effective and proven to reduce AVCs by 80% or more: fencing, fencing in combination with crossing structures, and road closures. Fencing by itself increases the barrier effect to wildlife movement; therefore, fencing combined with crossing structures, which improve connectivity, is the preferred mitigation measure in most North American landscapes. To be effective, crossing structures must be used in combination with fences that are at least several miles (5 kilometers (km)) in length to both direct animals to use the structure and to prevent them from accessing the road and traffic. In combination, wildlife crossing structures with

adequate fencing substantially reduce collisions for a wide variety of species while at the same time improve habitat connectivity. The Literature Review also evaluated measures for small animal species. Temporary or permanent road closures and road removal are effective measures that are occasionally implemented. As for large mammals, fences, in combination with crossing structures, are the most common mitigation measure deployed to protect small animals from road mortality as well as reduce the barrier effect of roads. Although effective, it was noted that road closures are usually a tactic only available to protected area managers to address traffic on protected area roads (e.g., parks, wildlife refuges), particularly when seasonal animal migrations occur.



ECONOMICS

The TPF Study conducted three different economic studies that updated and added new values to the cost-benefit analysis of WVC mitigation measures and synthesized and developed new passive use values for species of interest due to their mortality on North American highways. Although the passive use value studies did not cover all of North America's common species, economic values were described for deer, elk, wolves, grizzly bear, turtles, and Mojave desert tortoises of the southwest US. The individual passive use values (2020 US dollars (\$)) of these species ranged from over \$3,000 for an individual turtle, \$5,075 for a deer, \$27,751 for an elk and more than \$4 million per grizzly bear.



The final economic study developed a cost-benefit analysis of WVC mitigation measures with new calculations for the direct costs of crashes with large wildlife species and feral/domestic animals. It compared the cost of preventing those AVCs with the costs of implementing mitigation measures and maintaining them over their service life. The average cost per crash in 2020 US dollars was \$19,089 for deer, \$73,196 for elk, \$110,397 for moose, and \$82,646 for cattle and horses. These figures were significantly higher for these three species, more than three-fold, than in a journal article published by many of the same authors in 2009.

ECOLOGY

Four research projects were selected by the TPF Study's Technical Advisory Committee to assess the ecological consequences of AVCs and the effectiveness of mitigation measures.

The first project took advantage of over a decade of existing data from the Canadian Rocky Mountains to provide novel and rare details on the links between road mortalities and the demographic structure of an adjacent elk population in an evaluation of elk-vehicle collision (EVC) patterns. The results help inform the design of EVC mitigation measures that target the most vulnerable demographics of the elk population - subadults and males.



The second project had the luxury of utilizing many years of data that helped to evaluate the long-term ecological consequences of wildlife crossings with fencing. Use of unique data sets allowed the project to determine species-specific and community level use of the crossings in the Banff National Park and Montana study areas. It also allowed researchers to explore the long-term effects of crossing design types, habitat, and other factors that best explain species-specific variations in crossing use. The study confirms the species-specific value of

measuring wildlife crossing structure performance – leading to a primary recommendation that a variety of wildlife crossing structure designs be considered an essential part of a well-designed mitigation system for the diverse fauna of western North America. It found that large overpasses and open span bridges conveyed a higher diversity of species than other smaller crossing types. This project's findings can help inform future highway projects, so that they more fully consider how their crossing designs help or harm the passage of particular species or ecological flows.

The third project evaluated the ecological and cost effectiveness of fencing to reduce collisions with large mammals. The study found that wildlife exclusionary fencing created declines in WVCs for common ungulates - elk, mule deer, and white-tailed deer - by up to 96%, although reductions for large carnivores were much lower. It was estimated that in a ten-year period, fencing provided a net economic gain of more than \$500,000 per kilometer, due to reduced ungulate-vehicle collisions on the highway studied in Canada.

The last project tested five different electric barriers to determine how well they keep large



wildlife from accessing highways and traffic at road access points or fence ends. Four of the five electric barriers tested created nearly a complete barrier to black bears, the subject

of the electric barrier study. The project also found that double-wide cattle or wildlife guards (4.6-6.6 m (15-22 ft)) are best for ungulates.

DESIGN

Four of the research projects explored various facets of wildlife crossing designs that sought to increase WVC reductions, habitat connectivity, and cost effectiveness.

The first project described the use of fiber reinforced polymer (FRP) materials for a large wildlife overpass, focusing on the crossing structure and other design elements, such as fencing. The preliminary design of an FRP wildlife overpass for a specific crossing location allowed researchers to document an example of a feasible, efficient, and constructible alternative to conventional steel and concrete materials. The benefits of FRP materials were maximized through their use in the crossing structure, concrete reinforcement, fencing, and light and sound barriers, which were estimated to cost 5% less than a concrete structure with wood fencing and jump-outs.

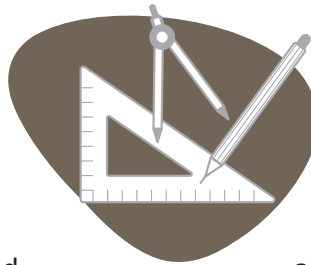

structure, except for one species of mole.

The third study evaluated different “jump-outs” designed to address problems that arise when exclusionary fencing is used to separate wildlife from highways and traffic. Animals can get caught on the inside of fenced road corridors and need to be able to safely exit. The experiment’s modified jump-outs nearly doubled the success of mule deer in escaping the fenced road corridor; however, they had little effect on white-tail deer and further investigation into modifications is warranted.

The fourth and final study of the design chapter evaluated large underpasses used by large mammals and determined whether the addition of ledges and rock piles could support underpass use by, and safe passage of, small animals. The study found that a few species may not benefit from the ledges and rock piles due to predator-prey relationships, and others may not be affected at all by such underpass treatment. Increased users included mice, rats, and rabbits (all prey species for larger carnivores), as well as snakes, foxes, and coyote. Skunk and bobcat use decreased, and there was no change in underpass use by lizards, squirrels, raccoons, and deer.

The second project was a case study that evaluated an elevated road that allowed toads and other small animals to pass underneath the structure safely. Referred to as an elevated road segment (ERS), it included four new ERS designs for high volume roads. All small animal species that were detected in the adjacent forest habitat were also detected under the ERS

PRACTICE

The variety of research projects and the Literature Review conducted for the TPF Study contributed to an updated body of knowledge regarding the effectiveness of AVC mitigation measures and their ability to provide habitat connectivity. These new options, designs, and best practices provided an opportunity to develop a Manual that focuses on the mitigation measures that were found to be successful as well as cost effective. It is designed for practitioners in

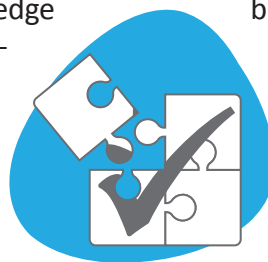

transportation planning, design, and implementation and contains solutions that address a broad range of environmental conditions, road and traffic characteristics, design criteria, fencing elements/treatments, implementation procedures, and evaluation methods. It focuses only on those mitigation measures that were found to be effective by the literature review.



INTRODUCTION

In 2003, Island Press published the first book on road ecology in North America, *Road Ecology: Science and Solution*. Fourteen leading ecologists and transportation experts from different fields came together to articulate the principles and the state-of-the-science in the emerging field of road ecology. They demonstrated the application of those principles for those interested in studying, understanding, or minimizing the ecological effects caused by roads and vehicles. Diverse theories, concepts, and models in this “new field” were integrated to establish a coherent and accessible framework for transportation policy, planning, and projects.

Two major subjects in that pioneering book were wildlife-vehicle collisions (WVCs) and the barrier effect that roads and traffic have upon wildlife movement and ecological connectivity. Soon after the book was published, the federal Safe, Accountable, Flexible, Efficient Transportation Equity Act: A Legacy for Users or the SAFETEA-LU Act (Public Law, 109-59) was passed in 2005. It included the requirement that a national study be conducted to determine how best to reduce WVCs. The completed study was entitled the Wildlife-Vehicle Collision Reduction Study: Report to Congress (Huijser et al. 2007) and it included the accompanying Wildlife-Vehicle Collision Reduction Study: Best Practices Manual (Huijser et al. 2008) to support practitioners.



Figure 1: Herd of elk crossing a rural roadway in the Yellowstone River valley of Montana. (Renee Callahan, ARC Solutions).

Over a decade later, this Transportation Pooled Fund Study, TPF-5(358) Study (TPF Study) seeks to update the current state-of-the-science on reducing WVCs, as well as explore effective measures to overcome the barrier effect of roads and traffic on wildlife. In areas where there were gaps in information, the TPF Study supported research projects that more thoroughly explored particular highway WVC mitigation measures or improve habitat connectivity. Thus, the focus of the TPF Study was to evaluate the importance of addressing and reducing animal-vehicle collisions (AVCs) – a combination

of collisions with both wildlife and domestic livestock - and maintaining connectivity for wildlife populations in the US and Canada. Through a literature review, ten research projects, and a best practices training manual, four broad themes were addressed: economics, ecology, design, and practice. The TPF Study was broader in scope than the national WVC reduction study of 2007, in that it addressed habitat connectivity while also evaluating medium- and small-bodied mammals in addition to amphibians and reptiles.

This Final Report serves as a synthesis of the completed TPF Study and provides a summary of the literature review, each of the 11 research projects, and the best practices manual (Manual). Detailed final reports for these efforts and other supporting materials may be accessed and downloaded from the project’s website.

To learn more, please visit: www.tpf-5-358-wvc-study.org



This Final Report provides readers with the most salient findings of each research project then directs them to each research project's final report for more detailed information. In total, the findings of the TPF Study offer practitioners and scientists the latest informa-

tion to support their efforts to reduce collisions with large animals – wild and domestic - as well as take into consideration effective measures that provide for the safety and habitat connectivity of all sizes of mammals, amphibians, and reptiles.

Wildlife Vehicle Collision Reduction and Habitat Connectivity

- Pooled Fund Study, TPF-5 (358), Task 1

REDUCE

Wildlife Vehicle Collisions

INCREASE

Habitat Connectivity

IMPLEMENT

Cost Effective Solutions

RESEARCH REPORTS

Cost effective solutions: Animal-vehicle collision reduction and habitat connectivity - *synthesis*

Economics



Cost effective solutions: Incorporating wildlife passive use values in collision mitigation benefit-cost calculations

Cost effective solutions: Incorporating deer and turtle total value in collision mitigation benefit-cost calculations

Cost effective solutions: Cost-benefit analyses of mitigation measures along highways for large animal species: An update and an expansion of the 2009 model

Design



Improving connectivity: Innovative fiber-reinforced polymer (FRP) structures for wildlife, bicyclists, and/or pedestrians

Research to inform passage spacing for migratory amphibians and to evaluate efficacy and designs for elevated road segment (ERS) passages (USGS)

Wildlife barriers: Modified jump-outs for white-tailed deer and mule deer

Internal structural cover and ledges facilitate the use of large underpasses for multiple wildlife species and groups (USGS)

Cost effective solutions: Animal-vehicle collision reduction and habitat connectivity - *literature review*

Ecology



A comparison of elk-vehicle collision patterns with demographic and abundance data in the central Canadian Rocky Mountains

Long-term responses of an ecological community to highway mitigation measures

A before-after-control-impact study of wildlife fencing along a highway in the Canadian Rocky Mountains

Wildlife barriers: The effectiveness of electrified barriers to keep large mammals out of fenced road corridors

Practices



Cost effective solutions: Best practices manual to reduce animal-vehicle collisions and provide habitat connectivity for wildlife



All reports, recorded presentations and other project resources can be found here:

http://tpf-5-358_WVC-Study.org

Figure 2: Summary of the TPF Study Final Report's four themes and their associated projects.



TPF STUDY OVERVIEW

The TPF Study developed, selected, and provided support for, priority research of new wildlife mitigation solutions, as well as explored and encouraged collaboration on research and implementation of wildlife mitigation measures by state Departments of Transportation (DOTs), land management agencies, wildlife agencies, and their partners in both the US and Canada. To carry out its objectives, the TPF Study was comprised of two primary tasks.

Task 1 identified cost-effective solutions that integrate highway safety and mobility with wildlife conservation and habitat connectivity. This was a unique opportunity to synthesize current knowledge from the US, Canada, and internationally on effective mitigation measures that reduce AVCs. It then sought to improve the cost-benefit analyses of mitigation measures that are used to reduce AVCs and field-test several improved mitigation designs

and technologies. Finally, it coordinated and provided outreach to TPF Study partners and their stakeholders. The Task 1 team was led by the Western Transportation Institute (WTI) at Montana State University.

Task 2 investigated how to strategically integrate highway mitigation for wildlife and provide for habitat connectivity in transportation planning and procedures. Task 2 was conducted by a different research team than for Task 1 and its activities are not discussed in this final report. The final report for Task 2 may be found at: <https://www.dot.nv.gov/home/showpublisheddocument/20776/637968476353500000>.

An overview of the approach used in Task 1 is summarized below. The activities and research conducted are the basis for the reports synthesized for this Final Report.

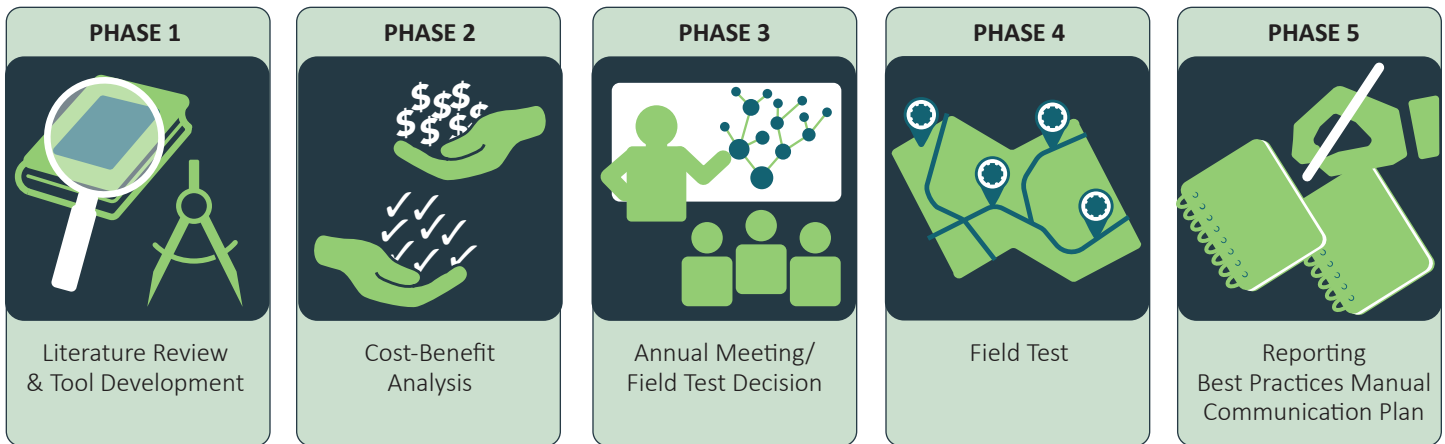

Figure 3: The five-phase process used for Task 1 of the TPF-5(358) Study.

TASK 1 RESEARCH REPORTS SYNTHESIZED IN THIS FINAL REPORT

As summarized in Figure 3, a five phased approach was used to conduct Task 1. This approach resulted in a variety of studies that were generated and conducted over three years. It includes a literature review, three separate economic studies, three ecological studies, and four studies on new designs for wild-

life crossing structures or associated design features (e.g., jump outs - egress structures for animals on the traffic side of highway fencing). It concludes with a manual on best practices for deploying mitigation measures that reduce WVCs or improve habitat connectivity.

LITERATURE REVIEW

The first activity for TPF Study Task 1 was to review the existing literature and ongoing research on the effectiveness of mitigation measures aimed at:

- 1 reducing collisions with large animals, including livestock, and improving human safety;
- 2 improving or maintaining habitat connectivity for wildlife through safe crossing opportunities, regardless of the size of the species (mammals, amphibians, reptiles);
- 3 identifying new and emerging technologies that facilitate wildlife movement and reduce WVCs.

Information was compiled, evaluated, and reported. The review used international transportation and ecological databases such as the Web of Science, Scopus, and Google Scholar, as well as proceedings from conferences and other professional reports and papers.

COST BENEFIT ANALYSES OF MITIGATION MEASURES

Cost-benefit analysis (CBA) for a variety of WVC mitigation measures was conducted as part of the TPF Study. The CBA's methods were similar to those developed by Huijser and others (2009) on their seminal work on this subject. The authors of the 2009 paper are also part of the TPF Study Task 1 research team. An important component of the CBA for mitigation measures is the value of wild-

life, specifically, *the economic value of wildlife not killed* by investing in the deployment of the mitigation measure. In the initial study (Huijser et al. 2009) the economic value for wildlife was simply the average hunting license cost for deer, elk, and moose. The TPF Study's final report also summarizes two economic studies that developed or describe passive use values for a variety of species from whitetail



Figure 4: A representation of species described with passive use values in the cost benefit analysis. Clockwise: Mojave desert tortoise (*Gopherus agassizii*) (Elizabeth Fairbank, CLLC), White-tailed deer (*Odocoileus virginianus*) (N Hetherington, WTI/MSU), Wolf (*Canus lupus*) (Jim Peako, NPS), and Elk (*Cervus elaphus*) (N Hetherington WTI/MSU).



deer (*Odocoileus virginianus*) and elk (*Cervus elaphus*) to wolves (*Canus lupus*) and Mojave desert tortoise (*Gopherus agassizii*). Incorporating these new economic values into a CBA

of WVC mitigation measures is a significant improvement on the simplistic, nominal values (costs of big game hunting fees) used as the economic basis for conserving wildlife.

RESEARCH PROJECTS

A Technical Advisory Committee (TAC) was formed with a representative from each of the 13 contributing TPF Study partners. The TAC requested that the members of the Study’s research team prepare and submit research proposals they thought might be most useful to explore. The TAC selected, via voting, projects that best addressed the ecological, economic, technical, safety, or design needs of the mitigation measures of greatest interest to their agencies. More proposals were submitted than the TPF Study could fund; therefore, what emerged were the ten best research projects.

Some projects required new field experiments to collect data and test hypotheses, while others took advantage of existing field data from past or current projects being conducted by research team members. Examples of research proposals that emerged using existing data include a meta-analysis of wildlife species responses to wildlife crossing structures and a review of data from existing drainage culverts and the factors affecting their use by small mammals. These data were analyzed to provide new and significant findings.

BEST PRACTICES MANUAL

The Best Practices Manual (Manual) offers practical information on the application of WVC mitigation measures and habitat connectivity improvements. It is designed for practitioners in transportation planning, design, and implementation. It contains solutions that address a broad range of environmental conditions, road and traffic characteristics, design criteria, fencing elements/treatments, implementation

procedures, and evaluation methods. It focuses only on those mitigation measures that were found to be effective by the literature review. For each measure, the Manual will include a general description, implementation steps, design guidelines, issues and concerns, costs, measured benefits and impacts, real-world examples of the tool in use, and references and contacts in case studies.

CRASH DISTINCTION TERMS

In this report, four similar but distinct terms and their acronyms are used to describe crashes with animals depending on the species in-

involved. Table 1 provides an overview of these distinctions.

Table 1: Distinctions between crash terms

| Acronym | Term | Applications |
|------------|----------------------------|---|
| AVC | Animal-Vehicle Collision | Broadest category; refers to domestic animals and wildlife. |
| WVC | Wildlife-Vehicle Collision | Refers to all wildlife species. |
| DVC | Deer-Vehicle Collision | In some databases, deer can be separated out. |
| EVC | Elk-Vehicle Collision | In some databases, elk can be separated out. |



LITERATURE REVIEW OF MITIGATION MEASURES

Background

A literature review was conducted which compiled, evaluated, and synthesized studies, scientific reports, journal articles, technical papers, and other publications from the US and Canada and incorporated other global-

ly pertinent materials. The review sought to determine the effectiveness of 24 different mitigation measures at reducing AVCs and whether those same measures had any impact on maintaining or improving habitat connectivity.



Figure 5: A variety of large and small wild animal species, free ranging livestock, and feral horses and donkeys are addressed in the Literature Review. Red squirrel (*Sciurus vulgaris*) (N Hetherington, WTI/MSU), Wild horses (*Equus ferus*) (Dreamstime), Painted turtle (*Chrysemys picta*) (C M Highsmith), Coyote (*Canis latrans*) (N Hetherington WTI/MSU), Moose (*Alces alces*) (Jim Peako, NPS), Bull snake (*Pituophis catenifer sayi*) (J W Frank, NPS), Elk (*Cervus canadensis*) (N Hetherington WTI/MSU), Pika (*Ochotona princeps*) (J Waller, NPS), Pine marten (*Martes americana*) (J W Frank, NPS), Holstein cow (*Bos taurus*) (Adobe stock), Tiger salamander (*Ambystoma tigrinum*) (N Herbert, NPS), Wolf (*Canis lupus*) (Jim Peako, NPS), Mojave desert tortoise (*Gopherus agassizii*) (F Deffner, USFWS), Bobcat (*Lynx rufus*) (Neal Herbert, NPS).



Mitigation measures were divided into three strategies:

- 1 those that sought to change driver behavior (11 measures),
- 2 those that sought to modify animal behavior or population size (11 measures), and
- 3 measures that separated animals from traffic and the road surface (two measures).

The literature review highlights the most effective approaches for reducing crashes with large wild mammal species, small wild animal species, free ranging livestock, as well as feral horses and donkeys.

What Was Learned

Of the 24 mitigation measures that were examined in the literature review, the ten that were found to achieve at least a 50% reduction in AVCs are summarized in Table 2. Color coding in Table 1 indicates how well each mitigation measure performs in reducing AVCs and how effective it is in increasing the permeability of the road for animal movement. Negligible impact is noted in red and moderate is noted in yellow. Costs of the mitigation measures, if available, are reported in the final report for the TPF Study's literature review.

The literature review found only three highly effective mitigation measures that are proven to reduce AVCs by 80% to 100%: fencing, fencing in combination with crossing structures, and road closures (Table 2). It was noted that road closures are usually a tactic only available to protected area managers to address traffic

on wildlife refuge or park roads, particularly when seasonal animal migrations occur. Fencing, by itself, increases the barrier effect to wildlife movement; therefore, fencing combined with crossing structures, which improve connectivity, is the preferred mitigation measure in most North American landscapes. To be effective, crossing structures must be used in combination with fences that are at least several miles (5 kilometers (km)) in length (Huiser et al. 2016) to both direct animals to use the structure and to prevent them from accessing the road and its traffic. In combination, wildlife crossing structures and adequate fencing substantially reduce collisions for a wide variety of species while at the same time improve habitat connectivity (Table 2).

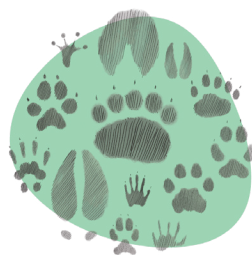

Table 2: Summary of the ten most effective of the 24 mitigation measures reviewed in the literature review report; they had to achieve at least a 50% reduction in AVCs with large mammals. Each measure was evaluated to determine if it reduced the barrier effect of roads to wildlife movement.

| Measure | Effectiveness in reducing collisions with large mammals | Effectiveness in reducing the barrier effect of roads and traffic |
|--|--|---|
| Mitigation measures aimed at influencing driver behavior | | |
| Seasonal wildlife warning signs | 9-50% - Moderate | None - Ineffective |
| Roadside animal detection systems (RADS) | 33-97% - Effective | None - Ineffective |
| Seasonal closure | 100% during closure - Effective | Reduces barrier effect of traffic but not the road itself (during closure only) |
| Increase visibility: roadway lighting | 57% - 68% - Moderate | None - May increase barrier effect for some species. |
| Reduce speed: traffic calming measures | Unknown-59% - Moderate | Unknown |
| Mitigation measures aimed at influencing animal behavior or population size | | |
| Wildlife culling | 49-84% - Effective | None - Ineffective |
| Wildlife relocation | 30-94% - Effective | None - Ineffective |
| Mitigation measures that attempt to separate animals from the road | | |
| Wildlife barriers (fencing/walls/boulders) | 80-100% (83% on average) - Effective | None - Fences alone make the road into more of a barrier than without fences |
| Underpasses and overpasses without fencing | Varies greatly depending on structure design and/or location | Barrier effect can be reduced |
| Underpasses/overpasses and fencing | 80-100% (83% on average) - Effective | Barrier effect can be reduced |



At this time, the ability to reduce AVCs with vehicle-based animal detection technology, especially in autonomous or “smart” vehicles, is poorly understood. That is, their ability to reduce AVC rates on actual highways has not been precisely studied. Early research for these technologies has paid attention to their ability to detect animals along, or on the road; it has not focused on quantifying the resultant reduction in AVC rates. While future research may prove that these new vehicle-based technologies significantly reduce AVC rates with large mammal species on North American roads, the on-board sensors typically do not detect smaller species so have little potential for reducing WVCs with small mammals, reptiles, and amphibians. Furthermore, this technology does not reduce the barrier effect of the road and traffic on wildlife.

The majority of the eleven evaluated measures that seek to change driver behavior - making motorists more alert and slowing their vehicle speed to improve reaction time to animals on the road - have by and large been ineffective. Traditional warning signs, educational campaigns, reducing posted nighttime speed limits, and other measures, although commonly deployed, have scant evidence to prove that they reduce AVCs by more than 50% and have often been found to reduce AVC rates by only single digits. Only four measures in this group were found to achieve at least a 50% reduction in AVC rates (Table 2): night-time lighting, roadside animal detection systems, seasonally deployed wildlife warning signs, and seasonal road closures. None of these four measures improve habitat connectivity over the long-term.

Of the eleven measures that seek to change animal behavior or manage population size, two were found to reduce AVC rates by 50% or greater. Both sought to manage the size of the population of the wildlife species involved, either by culling or relocation (Table 2). Neither of these measures reduced the barrier effect of the road for wildlife.

Table 2 does not report the effectiveness of the mitigation measures aimed at reducing crashes with large domestic mammal species, such as cows or horses. Those were evaluated in the literature review and are described in its final report; however, it was found that the most effective measures were similar to those effective at reducing WVCs.

The literature review also evaluated measures for small animal species. Temporary or permanent road closures and road removal are effective measures that are occasionally implemented. As with large mammals, fences, in combination with crossing structures, are the most common mitigation measure deployed for small animal protection from road mortality, as well as for reducing the barrier effect of roads.

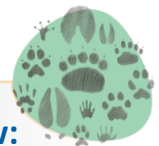

Link to the literature review:

<http://doi.org/10.15788/ndot2021.12>



Figure 6: Left: Mule deer (*Odocoileus hemionus*) on US95 overpass (NDOT). Right: Horses using underpass (NDOT).



ECONOMICS

As part of the TPF Study, three economic studies explored new valuation methods for wildlife species that could be incorporated into the next generation of cost-benefit analyses (CBAs) of WVC mitigation measures. In past studies the values associated with collision avoidance, related to injured or killed animals, have been limited to easily identifiable, direct use animal values, such as the cost of a hunting license. Another economic value that could be used is the restitution value for the loss of individuals of various species, as prescribed by government. For example, forty-two states in the U.S. have restitution values for the illegal loss of big game species (Edwards, 2017).

Another common method used to assign monetary value to the loss of an individual animal is the passive use value, or the value that society has given the animal. An individual animal's

passive use value is a fresh lens through which economists and transportation planners can view the monetary cost of North American wildlife killed on roads, beyond the price of a big game hunting tag. The studies explore not only the economic valuation of big game, but many other species as well - from carnivores to reptiles, some of which are listed under the U.S. Endangered Species Act.

What is passive use value?

The values individuals place on the existence of a given animal species or population as well as the bequest value of knowing that future generations will also benefit from preserving the species.

Incorporating Wildlife Passive Use Values in Collision Mitigation Benefit-Cost Calculations

Background

This economic research project explored the potential use of passive-use economic wildlife values to measure the effectiveness of the WVC mitigation measures and, in some instances, improve habitat connectivity. Passive use values are also known as non-use values, or the monetized value society has placed on the existence of a given animal species or pop-

ulation, as well as the knowledge that future generations will also benefit from the species' preservation. This project summarized the existing published literature for wildlife passive use value estimates for those species or populations that may be of interest to transportation specialists because they are known to suffer from animal vehicle collisions.





Figure 7: A representation of the wildlife included in the cost benefit analysis – clockwise, Elk (*Cervus elaphus*) (N Hetherington WTI/MSU), Grizzly bear cubs (*Ursus arctos horribilis*) (NPS), Wolf (*Canis lupus*) (Jim Peaco, NPS), and Mojave desert tortoise (*Gopherus agassizii*) (Flo Deffner, USFWS).

What was Learned

This study provided a summary of the current literature of wildlife passive use value estimates and per animal passive use values for selected species and populations (Table 2). They are available for use in highway mitigation measures and their CBAs throughout North America, where the species is present.

After summarizing the various passive use values of wildlife, the economic study provided an example of applying the passive use value of the grizzly bear to a particular 13.7-mile (22 km) road segment of U.S. Highway 93 (US-93), in western Montana, that passes through the Ninepipes National Wildlife Refuge (NWR). Currently, there are no mitigation measures for US-93 in the Ninepipes NWR. Applying the passive use value for grizzly bears in this specific road section resulted in estimated annual costs associated with grizzly bear roadkill of \$1.5 million in losses, based on the 15-year average bear mortality, to \$3.5 million, based on the

annual average values lost in the most recent three years (2016–2018) of the data set. By forecasting the application of 25-year mitigation measures (e.g., fencing) that significantly reduce bear mortality, the present discounted value of mitigation structures that would prevent these deaths is between \$17.5 million and \$40.8 million. Thus, highway mitigation measures would not only prevent grizzly bear deaths and protect motorists, but the public would realize a significant cost savings for the investment in mitigation measures.

The last segment of this research project describes a different type of economic study - a regional economic impact analysis (REIA). REIA's are rarely conducted for highway WVC mitigation measures because they utilize a different accounting framework, one that is generally a measure of the distributive economic impacts of a specific highway construction project on a local area or region.



Table 3: Estimated per-animal values, by species.

| Species | Setting | Basis of Value Estimate | Original Value per Animal (year of US Dollar value) | 2019 Value per Animal |
|--|--|--|---|--|
| Elk Passive use | 1989 survey of Yellowstone visitors (Duffield 1991) | Donation for winter range for 4,000 elk; contingent valuation | \$18,325 (\$1989) | \$36,925 |
| Elk Viewing | 1989-1990 survey of Yellowstone visitors (Duffield 1991) | Increased value per trip (contingent valuation)/per elk in population | \$8,802 (\$1989-90) | \$17,230 |
| Wolves Passive use in a protected area | 1993 national value per household for wolf recovery in Yellowstone (USFWS 1994) | Contingent valuation donation for recovery of 100 wolves | \$1,180,500 (\$1993) - National net value \$13,100- Regional (ID, MT, WY) net value | \$2,002,700 National; \$22,300 Regional |
| Wolves Value outside Yellowstone | 2005 survey of Yellowstone visitors (Duffield et al. 2006) | Contingent valuation donation to compensation fund for live-stock depredation (400 wolves) | \$42,910 (\$2005) | \$56,427 |
| Grizzly Bear Passive use | 1996 Regional and National household survey on Grizzly reintroduction (USFWS 2000) | Contingent valuation donation for recovery of 280 grizzly in Bitterroot Ecosystem | \$2,578,800 (\$1996) | \$4,133,000 |
| Mojave Desert Tortoise (1) | National value per household (Amuakwa Mensah et al. 2018) | Meta-analysis model for threatened reptile/passive use value | \$7,610 (\$2015) | \$8,179 |
| Mojave Desert Tortoise (2) | ESA project mitigation costs | Costs to protect species at Ivanpah Solar facility/passive use value | \$7,282 (\$2014) | \$7,883 |

An example REIA was conducted for this project based on the 2010 construction of mitigation measures for the expansion of US-93 in western Montana. It evaluated what the economic impact of constructing \$4.8 million in equivalent highway mitigation measures for wildlife would have upon two distinctly different Montana counties: rural Sanders County with a small population, and Yellowstone County, which is home to Billings - the largest city in the state. Results of the REIA estimated that the total economic impact of the same highway mitigation measures in Sanders County would amount to over \$5.9 million in

net economic impact but surpass \$8.2 million in Yellowstone County. This REIA demonstrated how larger, more complex economic areas will receive larger economic impacts from the same amount of construction of highway mitigation measures, compared to smaller, simpler economic areas.

Link to the final report:

<http://doi.org/10.15788/ndot2019.09>



Incorporating Deer and Turtle Total Value in Collision Mitigation Benefit-Cost Calculations

Background

This pilot study developed survey methods that could be appropriate for gathering statistically reliable data for models that estimate the passive use value of species commonly involved in WVCs. Currently, the economic values for the species used in the pilot are a missing component of CBAs related to the construction of exclusionary fencing and wildlife crossing structures. While there exist many natural resource economics publications on value estimates for wildlife, they almost entirely focus on either entire population value, threshold values, or values associated with significant changes in population size. Most of these are not applicable for use in CBAs of highway mitigation measures that reduce WVCs.

This project sought to develop a method to estimate economic values for animals within species that have generally not been the focus

of previous valuation work. Within this context the study had several objectives: 1) develop a reproducible survey instrument appropriate for eliciting survey responses which could be used to estimate total value estimates (including passive use values) *on an individual animal basis*; 2) test a draft version of the survey to determine its acceptance by respondents; 3) finalize the survey and conduct a full-scale random household survey in a test location on selected species; 4) analyze the survey data using accepted statistical modeling methods; 5) report the findings, including limitations of the analysis and suggestions for future research. The research was conducted in the State of Minnesota, and the species of interest were white-tail deer (*Odocoileus virginianus*) and turtles, such as painted turtles (*Chrysemys picta*) or snapping turtles (*Chelydra serpentina*). In Minnesota, WVCs with deer and turtles are a concern.



Figure 8: Species of interest in the Minnesota study. Clockwise: Blandings turtle (*Emydoidea blandingii*) (Andrew Cannizzaro) and White-tail deer (*Odocoileus virginianus*) (N Hetherington, WTI/MSU), public information sign, (Christopher Smith, MnDOT).



What Was Learned

Based on previous general population household surveys a target response rate of 16% of deliverable surveys was anticipated. The actual response rate from the Minnesota sample was just under 21%. This indicates that the survey was of interest to respondents and engaged a greater than expected share of recipients.

Based on the survey, an estimate of the total economic benefits (direct collision costs plus passive use costs) of an avoided deer-vehicle collision in Minnesota (MN) is \$8,325 + \$4,952

= \$13,277 in 2019 US dollars. For this estimate, direct collision costs account for 63% of the loss of a deer and passive use values account for the other 37 percent. An avoided collision with a turtle in Minnesota is worth an estimated \$3,070 in 2019 US dollars.



Link to the final report:

<http://doi.org/10.15788/ndot2021.09.1>

Key findings from wildlife vehicle collision structures survey

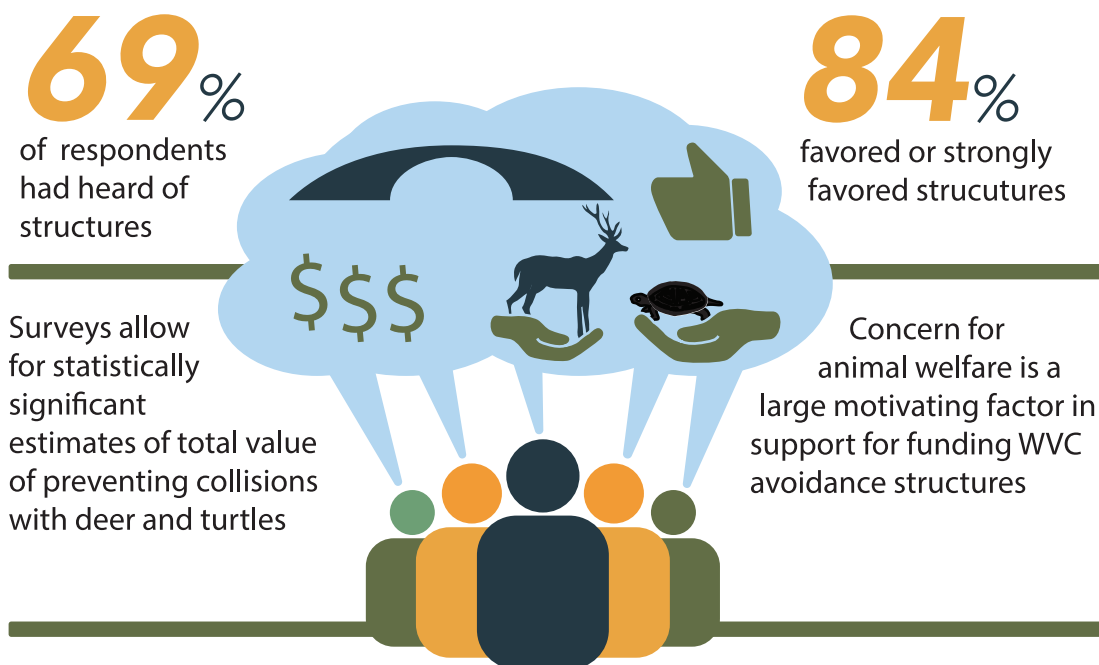

Figure 9: Key findings from the Minnesota household survey.

Update and Expansion of the WVC Mitigation Measures and Their Cost-Benefit Model

Background

Huijser and others (2009) published the first peer-reviewed journal article to establish estimates of the average cost of collisions with large mammals – moose, elk, and deer - in the USA and Canada. This TPF Study created an opportunity to update and expand upon those initial cost estimates. The research estimated the cost of the average collision with a deer (white-tailed deer and mule deer (*O. hemi-*

onus) combined), elk (*Cervus canadensis*), moose (*Alces americanus*), gray wolf (*Canis lupus*), grizzly bear (*Ursus arctos*), and free ranging or feral domesticated species including cattle, horse, and burro. The components included in the cost estimate were vehicle repair costs, costs associated with human injuries and fatalities, and passive use costs if available.



Figure 10: A sampling of animals used in the project to estimate cost of the average collision. Elk (*Cervus elaphus*) (Jacob W Frank, NPS), Grizzly bear (*Ursus arctos horribilis*) (N Hetherington, WTI/MSU), Wolf (*Canis lupus*) (Jacob W Frank, NPS), Wild horses (*Equus ferus*) (NDOT), and domestic cattle (*Bos taurus*) (N Hetherington WTI/MSU).

What Was Learned

The cost-benefit analyses were converted so that all costs were in 2020 US dollars (US\$) for each of the four categories used to estimate the average cost of collisions; vehicle repair, human injury, human fatality, and passive use

values. The project's estimates for the cost of vehicle repairs, human injury, and human fatalities have all increased sharply since the first estimates were completed in 2007 US dollars (Huijser et al. 2009) over a decade ago.

Table 4: Vehicle repair costs, average human injury costs and average human fatality costs per collision for deer, elk, and moose in 2007 and 2020.

| | Vehicle Repair Costs per Collision | | Average Human Injury Costs per Collision | | Average Human Fatality Costs per Collision | |
|--------------|------------------------------------|---------|--|----------|--|----------|
| | 2007 | 2020 | 2007 | 2020 | 2007 | 2020 |
| Deer | \$2,850 | \$4,802 | \$2,702 | \$6,116 | \$1,002 | \$3,408 |
| Elk | \$4,550 | \$7,666 | \$5,403 | \$14,579 | \$6,683 | \$23,200 |
| Moose | \$5,600 | \$9,435 | \$10,807 | \$26,811 | \$13,366 | \$46,400 |

Data regarding the proportion of moose (0.2) and deer (0.05) collisions that result in human injuries were used to estimate the cost of human injury in an average crash with a large wild ungulate. Based on these two proportions, the unknown proportion of elk collisions that result in human injuries was assessed at 0.1 percent. The human injuries were further categorized into three levels of severity and cost (in 2020 US\$); possible injury (\$77,200), non-incapacitating injury (\$151,100) and incapacitating injury (\$554,800). In 2007, these proportions and levels of severity resulted in the following average cost of human injuries to be \$6,116 in collisions with deer, \$14,579 with elk, and \$26,811 with moose; in this new evaluation, all three species collision estimates are significantly higher than in 2007 (Table 4).

Similar to human injury, the proportion of collisions resulting in human fatality were

used to estimate an average fatality cost of \$11,600,000 based on the US Department of Transportation's standard known as the "Value of Statistical Life". Compared to the expense of repairs and human injuries, the average cost of human fatality per crash grew even more significantly, with an increase of more than 300% than the amount Huijser and others (2009) estimated in 2007 US dollars (Table 4).

The last category, passive use value, is a new economic factor used to estimate the cost of an average collision with different large wildlife species. A summary of the passive use values of four large mammals in North America evaluated for the TPF Study can be found in Table 5. Passive use values for an individual of these species can range from \$3,000, to over \$4 million US dollars.



Table 5: Summary of wildlife values and avoided collision costs in (2020 US dollars (\$)) from both economic studies in the TPF that can be used for cost-benefit analyses (CBAs) of wildlife-vehicle collision (WVC) mitigation measures.

| Species | Passive use value (2020 US\$) ¹ | Notes | Average Passive use value (2020 US\$) | Source |
|-------------------|--|-------------------------------|---------------------------------------|---|
| White-tailed deer | \$5,075 | Outside a protected area | \$5,075 | Duffield & Neher 2021 |
| Elk | \$37,843 | In a protected area | \$27,751 | Duffield 1991, Duffield & Neher 2019 |
| | \$17,658 | In a protected area | | Duffield 1991, Duffield & Neher 2019 |
| Wolf | \$2,052,499 ² | In a protected area, National | \$40,342 | USFWS 1994, Duffield & Neher 2019 |
| | \$22,855 | In a protected area, Regional | | USFWS 1994, Duffield & Neher 2019 |
| | \$57,830 | Outside a protected area | | Duffield et al. 2006, Duffield & Neher 2019 |
| Grizzly bear | \$4,235,770 | For reintroduction | \$4,235,770 | USFWS 2000, Duffield & Neher 2019 |

¹ Conversion from 2019 to 2020 US\$ based on U.S. Department of Labor (2022).

² Not used in the calculation for the average as it relates to Yellowstone National Park.

The total costs associated with the average large wild ungulate-vehicle collision, based on vehicle repair costs, human injuries, and human fatalities, is reported in Table 6. Other potential direct costs such as towing, accident attendance and investigation, and carcass removal and disposal, are not included in this table. The hunting value of the animal concerned (a “direct use” value), was also not included. However, these costs are likely to be in the hundreds of dollars for each category, rather than in the thousands or tens of thousands, and are unlikely to substantially increase the cost estimates. The vehicle repair and occasional human injury and fatality costs of collid-

ing with a wolf or grizzly bear were considered similar to deer, burro was considered similar to elk, and cattle and horse were considered similar to moose.

In this study, the direct costs associated with vehicle repair, human injuries, and human fatalities, increased by over 200% compared to their 2007 values (Huijser et al. 2009). When the passive use values for deer, elk and moose are included, the direct costs of WVCs increased from 280% to over 400% compared to 2009, depending on the species.



Table 6: Total costs associated with large wild wildlife-vehicle collisions (in 2020 US dollars (\$)).

| Costs per collision | | | | | | | | |
|--------------------------|-----------------|-----------------|------------------|-----------------|--------------------|-----------------|-----------------|-----------------|
| Cost category | Deer | Elk | Moose | Gray wolf | Grizzly bear | Cattle | Horse | Burro |
| <i>Direct costs</i> | | | | | | | | |
| Vehicle repair | \$4,418 | \$7,666 | \$9,435 | \$4,418 | \$4,418 | \$9,435 | \$9,435 | \$7,666 |
| Human injuries | \$6,116 | \$14,579 | \$26,811 | \$6,116 | \$6,116 | \$26,811 | \$26,811 | \$14,579 |
| Human fatalities | \$3,480 | \$23,200 | \$46,400 | \$3,480 | \$3,480 | \$46,400 | \$46,400 | \$23,200 |
| Sub total | \$14,014 | \$45,445 | \$82,646 | \$14,014 | \$14,014 | \$82,646 | \$82,646 | \$45,445 |
| <i>Passive use value</i> | | | | | | | | |
| | \$5,075 | \$27,751 | \$27,751 | \$40,342 | \$4,235,770 | ? | ? | ? |
| Total | \$19,089 | \$73,196 | \$110,397 | \$54,356 | \$4,249,784 | \$82,646 | \$82,646 | \$45,445 |

The direct costs associated with vehicle repair, human injuries, and human fatalities, increased by a factor of 2.12 (for deer), 2.60 (for elk) and 2.69 (for moose), compared to the 2007 values (Huijser et al. 2009). When the passive use values are included, these factors increase to 2.88 (for deer), 4.19 (for elk) and 3.59 (for moose), compared to the 2007 values (Huijser et al. 2009).

Once the average cost of collisions with different large mammals was calculated, a CBA was conducted for four different types and combinations of mitigation measures; fence without dig barrier, fence with dig barrier, fence with jump outs and underpasses every 2 kilometers (km) (1.25 miles), and fence with an overpass every 24 km, an underpasses every 2 km between the overpasses and jump outs. The costs of the mitigation measures included their

design and construction, maintenance, and their removal at the end of the 25-year service life for fences and 75-year service life for the crossing structures. This resulted in CBAs that could identify the threshold values in either costs of WVCs per kilometer per year or WVC rates per kilometer per year (Table 6).

Results in Table 7 indicate, using the 3% discount rate, that if collision rates with deer are slightly greater than 1.5 per kilometer per year (~2.4 deer-vehicle collisions/mile/year), investments in underpass structures with fencing and jump outs will provide society with a net economic benefit. Similarly, collision rates with large-bodied moose can be lower than deer, 0.27 per km/yr (0.43 moose-vehicle collisions/mile/year), to meet the economic threshold where economic benefits to society exceed the costs of building the mitigation measures.

*1 A discount rate of three percent is often recommended for public infrastructure. Conducting CBAs for public works requires a discount rate to fairly compare the costs and benefits over long time periods in order to establish, on net, whether total benefits exceed total costs.



Table 7: Threshold values (in US dollars or crash rates) indicate when the costs of crashes involving three common ungulate species in North America are equal to the cost of the construction and maintenance of the mitigation measure. Four different types of mitigation measures are calculated. For the US dollar threshold values, a three percent discount rate*¹ was used.

| Threshold values | Fence (no apron) | Fence (apron) | Fence (apron), underpass, jump-outs | Fence (apron), under- and overpass, jump-outs |
|--------------------------|------------------|---------------|-------------------------------------|---|
| US\$/km/yr* ² | \$7,460 | \$11,558 | \$25,388 | \$32,030 |
| Deer/km/yr | 0.454 | 0.704 | 1.546 | 1.951 |
| Elk/km/yr | 0.119 | 0.184 | 0.403 | 0.509 |
| Moose/km/yr | 0.079 | 0.122 | 0.267 | 0.337 |
| Grizzly bear/km/yr | 0.002 | 0.003 | 0.007 | 0.009 |

The final analyses for this research project sought to determine if the severity of AVCs with large mammals has increased or decreased over time. The results indicate:

- Larger and safer cars have resulted in a decrease in the proportion of crashes with large mammals that result in human injuries.
- Synchronously, the proportion of crashes that resulted in property damage only has increased.
- There was no change in the proportion of crashes with human fatalities.

In conclusion, AVCs are not only dangerous but increasingly expensive. In general, when crash rates exceed relatively low levels, the installation and maintenance of mitigation measures can be economically justifiable. Communities who live with moderate AVC rates could experience real, significant cost savings by implementing effective mitigation measures.



Link to the final report:

<http://doi.org/10.15788/ndot2022.10>

*¹The discount rate for infrastructure is used to assure that the initial investment costs are balanced with the net benefits that accrue over time during the life of the project so that they are all in present value.

*² km/yr = kilometers per year





ECOLOGY

Four research projects were selected by the TPF Study's Technical Advisory Committee to assess the ecological consequences of AVCs and the effectiveness of mitigation measures. The first took advantage of over a decade of existing data from the Canadian Rocky Mountains to evaluate elk-vehicle collision patterns. Another project also had the luxury of utilizing many years of data that helped to evaluate the

long-term ecological consequences of wildlife crossings with fencing. The third project evaluated the ecological and cost effectiveness of fencing to reduce collisions with large mammals. The last project tested different electric barriers to determine how well they might keep large wildlife from breaching fencing to access highways and traffic at road access points or fence ends.

A Comparison of Elk-Vehicle Collision Patterns with Demographic and Abundance Data in the Central Canadian Rocky Mountains

Background

WVCs are a widespread phenomenon that are strongly influenced by the traits of the species, animal population density, local terrain, road design, and traffic volumes. The mortality rate of different ages and sexes can either buffer or exacerbate how a local wildlife population responds to cumulative collisions. However, the underlying patterns of WVCs are often analyzed without considering the demographic structure of the wildlife population.

The effect of traffic volume and population abundance on the rates and locations of WVCs can help natural resource and transportation managers predict the long-term viability of wildlife populations and assess when and where wildlife mitigation is most effective for targeted species. In the past, transportation agencies have often installed mitigation measures where roadkill is the highest; this focus may ignore locations where roadkill has already depressed populations and where recovery efforts are needed to avert a population crash.

This study sought to provide transportation professionals with data analyses that inform the design of effective mitigation strategies in areas where elk is a dominant species. It describes the demographic groups (age, sex, body condition) of elk that are most susceptible to elk-vehicle collisions (EVCs). The team then evaluated how elk abundance and traffic volume collectively and independently may influence EVCs seasonally and annually.

The study benefited from a wealth of EVC records that were collected year-round by Parks Canada Agency and the Alberta Natural Resources Service from 1986-2000. These EVCs occurred on unmitigated sections of highway in the central Canadian Rocky Mountains where collisions are a concern among park managers and motorists, alike.



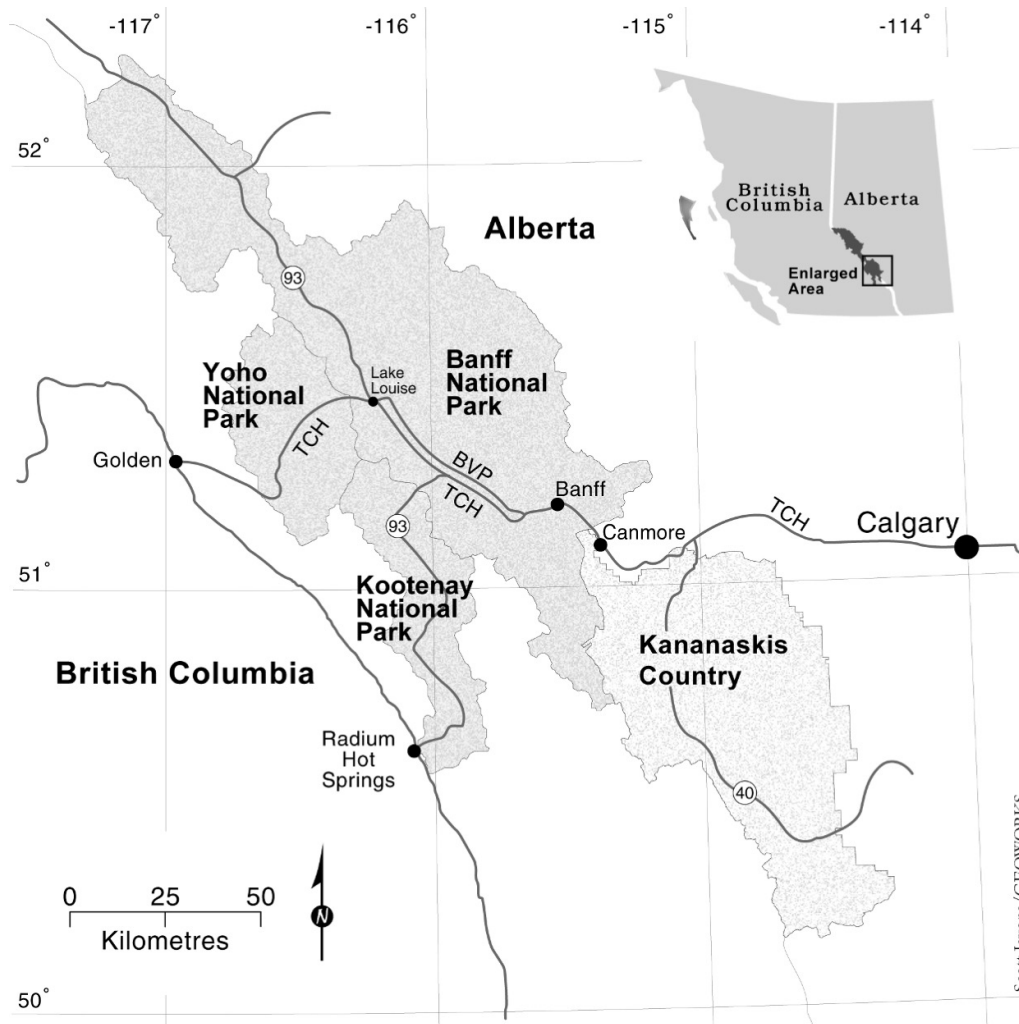

Figure 11: Location of study area and highways used to examine elk-vehicle collisions in the Central Canadian Rocky Mountains (TCH is Highway 1, the TransCanada Highway).

What Was Learned

The study provides novel and rare details on the links between road mortalities and the demographic structure of an adjacent large mammal population. While it is well established that roads can have negative impacts on biodiversity, it is less clear if road mortality is selective for particular types of individuals within a population. By incorporating population structure into the analysis of EVCs, this study provides new perspectives on the relative vulnerability to mortality of particular groups of animals within a population. These perspectives emerged from the information on local (i.e., near the road) wildlife populations in Canada that are typically unavailable for most road mortality studies (Ramp et al. 2005; Olson

et al. 2014). These insights add to the growing body of evidence that demographic-specific road mitigation efforts are needed to restore animal movements at the landscape scale (Ford et al. 2017).

Although all healthy elk were susceptible to collisions with vehicles, the study found that elk males and subadults were more prone to EVCs and collisions occurred more frequently in the autumn months. Research results also evaluated the effects of population abundance and traffic volume on EVC rates and found that elk abundance was the primary driver. Also, the study found that the magnitude of EVCs was negatively correlated to traffic volumes.



This finding, a decline in EVC rates corresponds with increasing traffic volumes, might be a good indicator that the population of elk in the study area is declining and the population could crash without management intervention, such as deploying highway mitigation measures that decrease EVC rates.

Collectively, the results help inform the design of EVC mitigation measures that target the most vulnerable demographics of the elk population - subadults and males. It highlights the importance in the seasonality of high EVC rates for this vulnerable demographic group, which is the autumn. In addition, declining EVC rates with increasing traffic volumes is a good

indicator that a population may be in decline and provides the evidence needed to implement mitigation measures before a population crash occurs. This is meaningful to transportation and natural resource managers because in many cases traffic volumes and vehicle collision data sets are easier to collect and compile relative to population abundance estimates.

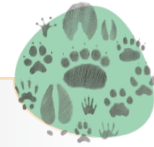

Link to the final report:

<http://doi.org/10.15788/ndot2021.09.5>



Figure 12: Elk crossing a congested roadway. (Shutterstock)

Long-Term Responses of an Ecological Community to Highway Mitigation Measures

Background

This project took advantage of two long-term programs to monitor wildlife use of crossing structures with exclusionary fencing. In Canada, seventeen years of data collection, regarding the use of 37 of the wildlife crossings constructed on the TransCanada Highway (Highway 1) in Banff National Park (NP) in Alberta was available for analysis. Five different types of crossing structure designs were evaluated: 1) open span bridge underpass, 2) creek bridge underpass, 3) elliptical, metal culvert underpass, 4) prefabricated concrete box underpass, and 5) wildlife overpass. Systematic, continuous year-round monitoring of the wildlife crossings began in 1996 and concluded in

2013. In the U.S., 39 locations received crossing structures during the reconstruction of U.S. Highway 93 that passes through the Flathead Reservation in western Montana. Six years of data were collected starting on 1 January 2010 and ending on 31 December 2015.

These two data sets allowed the project to determine species-specific and community level use of the crossings in the Banff National Park and Montana study areas. It also allowed researchers to explore the long-term effects of crossing design types, habitat, and other factors that best explain species-specific variations in crossing use.

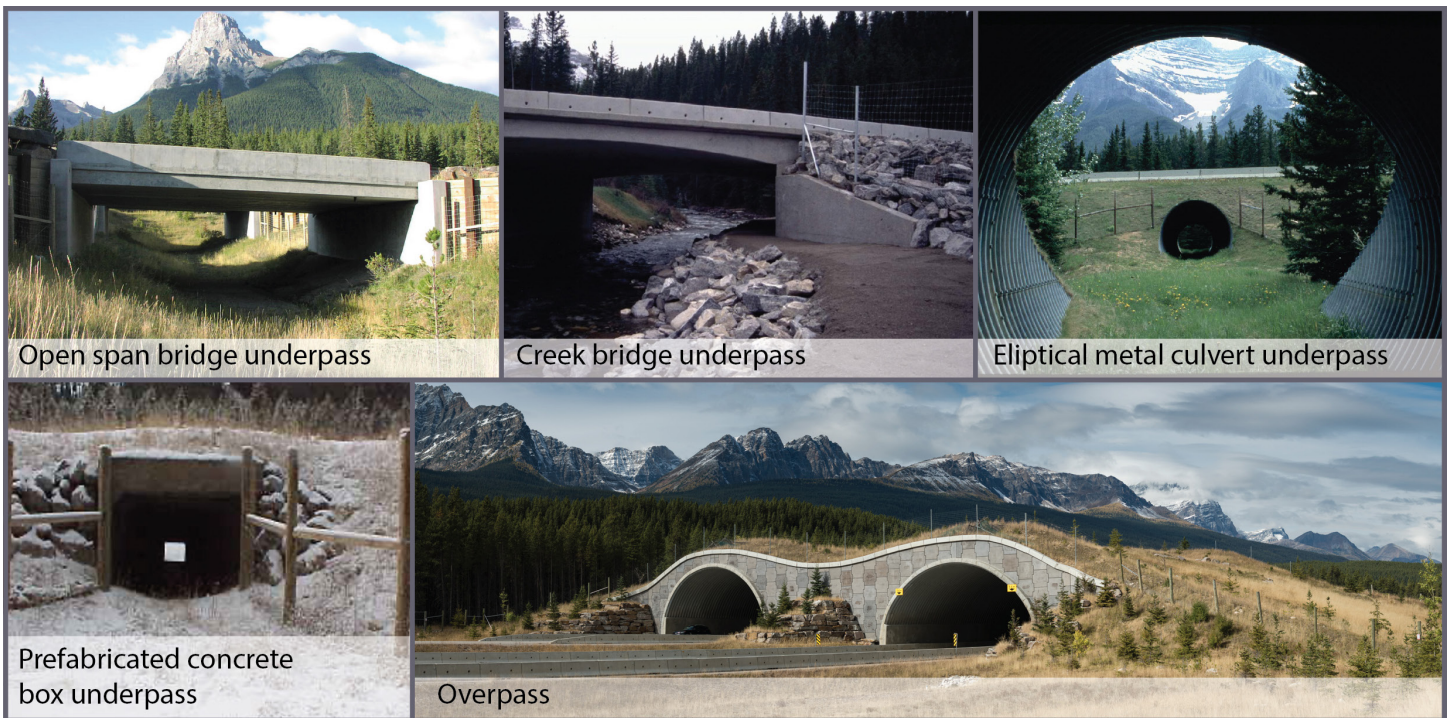

Figure 13: The five different types of crossing structure designs that were evaluated (Tony Clevenger, Overpass Adobe Stock).

What Was Learned

This study provides an unprecedented look at the long-term response of a large mammal community to highway mitigation measures. Results highlight the value of long-term monitoring for assessing the effectiveness of mitigation measures to reduce WVCs and enhance connectivity across major roads.

The study confirms the species-specific value of measuring wildlife crossing structure performance – leading to a primary recommendation that a diversity of wildlife crossing structure designs be considered an essential part of a well-designed mitigation system for the large mammal fauna of western North America. It



found that overpasses and open span bridges both conveyed a higher diversity of species than other smaller crossing types.

There was no evidence that could resolve the debate of whether a design incorporating a few large crossings or many small crossing structures performs better. It appears different species preferred different designs and structure densities. The results indicate that a 'several small' approach is a better strategy for coyotes, deer, and elk. Conversely, the "fewer large" crossings may be a better strategy for grizzly and black bears.

The non-linear effects of time on wildlife passage rates through the crossings structures suggest that short-term monitoring efforts may fail to accurately portray the ecological benefits of mitigation for populations and ecological communities. As managers rely on wildlife crossing structures to offset the impacts of road expansion projects and other disturbances, this study will help inform designs relying on wildlife crossings. It serves as an aid in the establishment of robust, long-term monitoring of the performance of mitigation measures. At the scale of ecological communities, the flows of mass (>16,000 tons of biomass) and

energy (>2840 gigajoules of metabolic load) are likely enough to alter the distribution of ecological processes in the Banff and Montana ecosystems. These altered ecological flows can have adverse consequences to seed dispersal, nutrient flows, trophic cascades and predation which are likely altered by the location and design of wildlife crossings. In both Banff and Montana, the dominance of a few crossing locations on ungulate passage rates likely means an inordinate density of animals, and therefore more intense browsing and higher amounts of fecal nutrient depositions, in a small area. This concentration of wildlife activity around the wildlife crossings could affect local ecological communities and could potentially contribute to the spread of diseases.

This project's findings can help inform future highway projects, so that they more fully consider how their crossing designs help or harm the passage of particular species or ecological flows.

Link to the final report:

<http://doi.org/10.15788/ndot2022.06>



A before-after-control-impact study of wildlife fencing along a highway in the Canadian Rocky Mountains

Background

Wildlife exclusion fencing has become a standard component of highway mitigation systems that are designed to reduce vehicular collisions with large mammals. It is often used in conjunction with wildlife crossing structures - overpasses or underpasses - to both reduce WVCs and maintain or improve habitat connectivity. Past work on the effectiveness of exclusionary fencing relied heavily on either control-impact (when no pre-construction

data was available) or before-after (when no controls are available) study designs. These two types of study designs limit inference and may confuse the effectiveness of mitigation with co-occurring processes that also change the rate of WVCs. To improve upon these study types and reduce confounding factors, this project employed a replicated before-after-control-impact (BACI)*¹ study design to assess fencing effectiveness along Highway 1,

*¹ Before-After-Control-Impact (BACI) experimental design is considered a statistically potent design to evaluate the effectiveness of mitigation measures to reduce the environmental impacts of a highway. Since the timing and location of the impact are known and if adequate pre-construction data are collected, the BACI design is considered an optimal choice for researchers.



the Trans-Canada Highway (TCH), in the Rocky Mountains of Canada. This BACI approach included both time and impact factors, with a control site (no fencing) and a comparably im-

pacted site (fenced highway segment). The second half of the project evaluated the resultant cost effectiveness of the fencing.



Figure 14: Common ungulates and large carnivores on, or near, roadways. Clockwise, Pronghorn (*Antilocapra americana*) (Shutterstock), Mule deer (*Odocoileus hemionus*) (iStock - N Hetherington, WTI/MSU) Elk (*Cervus elaphus*) (N Hetherington, WTI/MSU), Black bear (*Ursus americanus*) (Shutterstock) and, Mountain lion (*Puma concolor*) (iStock).

What Was Learned

The study found that the two fenced segments of the TCH had declines in WVCs for common ungulates species - elk, mule deer and white-tailed deer - by up to 96 percent. The WVC rates of large carnivores (e.g., black bear (*Ursus americanus*), cougar (*Puma concolor*)) had a much lower response, likely due to the combination of their low sample sizes and their ability to climb over the fencing design.

The BACI study was able to account for background changes in WVC rates, which were recorded at the unfenced control sites. The background changes could then be incorporated into the raw WVC rates observed at the impacted, or fenced, highway segments, which resulted in the adjustment of the WVC rate from 96% to 90% at one of the two control sites and an increase of the WVC rate by ten percent, at the other. The overall result is that the realized rate of WVC reduction effectiveness at the impact sites, those highway segments with fencing, was 82 percent.

When considering the total societal cost of ungulate collisions, fencing provided a net economic gain within the first year of construction. Over a 10-year period, it was estimated that the fencing would provide a net economic gain of more than \$500,000 per kilometer of impacted roadway in reduced ungulate-vehicle collisions.

The study results highlight the benefits of long-term monitoring of road mitigation projects (12 or more years of WVC data) and provide evidence of the effectiveness of fencing in reducing WVCs with large mammals, particularly ungulates. It also demonstrates that fencing is very cost-effective WVC mitigation measure.

Link to the final report:

<http://doi.org/10.15788/ndot2022.02>



Electrified Wildlife Barriers at Fence Ends and at Access Roads

Background

As the previous study exhibited, fences, in combination with wildlife crossing structures, are an extremely effective WVC mitigation measure and help maintain habitat connectivity. They reliably reduce collisions with large wild mammals by 80% or more when fencing extends along at least 5 kilometers (3 miles) of road (Huijser et al. 2016). Collisions that occur within the fenced road sections tend to be concentrated near the fence ends. In addition, gaps in fences, particularly where lower traffic-volume roads access the highway, can result in concentrations of

collisions inside the fenced road sections.

Researchers investigated the effectiveness of various types of electrified barriers to determine their efficacy at keeping large mammals, both carnivores and ungulates, from eluding fencing at access roads or at fence ends. In addition to field studies, this project combined data from the field with studies reported in the literature to conduct a meta-analysis of the effectiveness of different types and dimensions of barriers for both ungulates and carnivores.



Figure 15: An example of an electrified barrier at a fence-end. (Marcel Huijser)

What Was Learned

The researchers developed a series of electrified barriers that could be deployed, where access roads pass through the highway fencing, to keep large mammals from passing through the wildlife exclusionary fencing. Five types of barriers were tested on black bears: electric mats, three types of electrified gates, and electrified wires that crisscrossed the road adjacent to the fence gap but could be driven over. They found that a combination of electric fence and four of the five electric barriers created nearly a complete black bear barrier.

Based on the combination of the black bear field study and published literature, the project found that single-wide cattle or wildlife guards (2.1-3.0 m (7-10 ft)) were effective for

some ungulate species (species with hooves), but double-wide cattle or wildlife guards (4.6-6.6 m (15-22 ft)), consisting of round bars or bridge grate material situated above a pit, were generally recommended for ungulates. These types of barriers did not create an effective impediment for species with paws, including many carnivores. However, electrified mats or electrified guards did act as a barrier for both ungulates and species with paws. The electrified barriers needed to be 4.6-6.6 m (15-22 ft)) wide to prevent animals from jumping across.

Link to the final report:

<http://doi.org/10.15788/ndot2022.09.30>



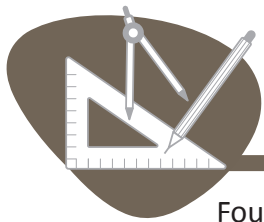

DESIGN

Four of the research projects explored various facets of wildlife crossings designs. The first described the use of fiber reinforced polymer materials for a large wildlife overpass, both for the crossing structure as well as for other design elements such as fencing. The second project was a case study that evaluated an elevated road that allowed toads and other small animals to pass underneath the structure safely. The third study evaluated different “jump-outs” designed to address problems that arise when deploying exclusionary fencing to separate wildlife from highways and traffic. The fourth and final study of the design chapter evaluated large underpasses for large mammals and determined whether the addition of ledges and rock piles could support underpass use by, and the passage of, small animals.

Fiber-Reinforced Polymer Wildlife Crossing Infrastructure

Background

Ecologists and engineers are constantly exploring new methods and adapting existing techniques to improve AVC mitigation measures, increase motorist safety, and conserve wildlife species. Wildlife crossing structures, combined with fences, are some of the most effective mitigation measures employed around the world. They are crucial for highway mitigation strategies, so there is a need for new, resourceful, and innovative construction techniques. This project explored the applications and feasibility of fiber-reinforced polymer (FRP) materials for an innovative wildlife overpass design. The use of FRP composite materials continues to increase due to their high strength-to-weight characteristics, long service life, and low maintenance costs. They are also highly customizable in shape and geometry, and in the materials used for their resins and fibers. The future for FRP is bright as manufacturers continue to research and develop commercial applications that incorporate more recycled plastics and bio-based materials.

What Was Learned

The preliminary design of an FRP wildlife overpass in the US-97 location serves as an example of a feasible, constructible alternative to using conventional steel and concrete materials. The reduction of weight when using FRP allows for more efficient transport of prefabricated bridge elements and a construction process that

This project explored what is known about FRP composites, their current use for bridge structures, and how they could be adapted for use in crossing structures at a real-world design location. Working with the California Department of Transportation (Caltrans) and California Department of Fish and Wildlife (CDFW), the selected site for this project was a 12-mile section of US Highway 97 (US-97) in Siskiyou County, California. The benefits of FRP materials were maximized, through their use in the design of a US-97 overpass structure, wildlife fencing, jump-outs, and light/sound barriers. Collaborating with Caltrans engineers helped identify the challenges and limitations of using FRP materials in an overpass structure by a state DOT. The final wildlife crossing design was used to evaluate the life cycle costs of using FRP materials in an overpass structure and other related design elements compared to traditional materials (e.g., concrete, steel, and wood).

utilizes smaller and more mobile equipment. The accelerated bridge construction technique, combined with a reduction in maintenance and an increased service life, could result in significant cost savings when using FRP compared to traditional bridge materials.



Over twenty FRP manufacturers and their products were reviewed to determine which

had materials that were feasible, or adaptable, for use in an FRP wildlife overpass design.

Four key criteria were used to identify and ultimately select the materials that would be useful for the project:

- ① product capabilities for use in a wildlife overpass,
- ② costs in manufacturing, transportation, and construction,
- ③ product aesthetics, and
- ④ manufacturer interest in using their product(s) for a wildlife overpass and their support when addressing any design challenges.

The Crossing Structure

The US-97 design site superstructure needed to be 35 m in length, to span the highway at Grass Lake Summit (Figure 16), and 50 m wide

to accommodate elk; the 35 m length would be sufficient to cross the existing 3 lanes of traffic.

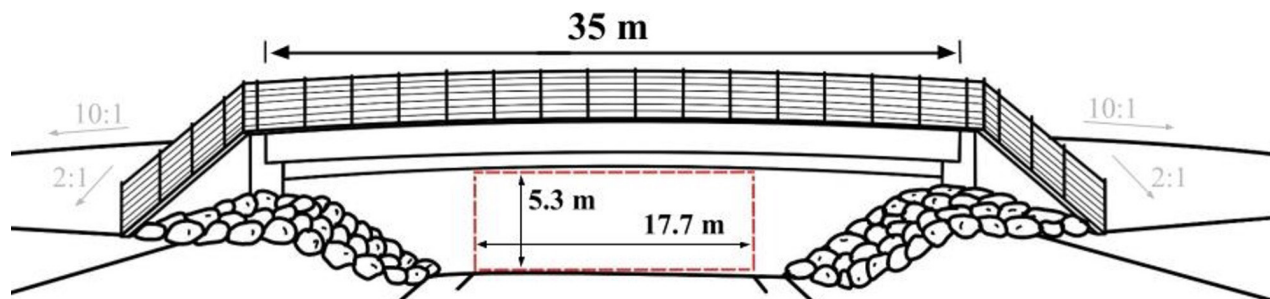

Figure 16: Elevation view of the US-97 wildlife overpass. Not Drawn to scale

The superstructure selected for the overpass was an FRP composite tub (CT) girder produced by Advanced Infrastructure Technologies, LLC (AIT). The girders were corrosion resistant and low maintenance (Figure 17) and much lighter in weight than precast concrete girders or steel beams. Each FRP assembly unit was comprised of two CT girders spaced at 2.3 m and connected with a thin precast concrete deck. These precast assembly units reduced the time required to crane in all the girders and reduced the need to build forms

for the concrete deck. Once all the pieces of the 50 m-wide superstructure was assembled, the assembly units were connected with high-strength joints. A cast-in-place concrete deck was placed on top of the assembly units and a curb at the edges of the crossing structure retained soil on the crossing (Figure 18). Then the structure was ready for the addition of other key components – light and sound barrier fencing on both sides, soil, and landscaping.



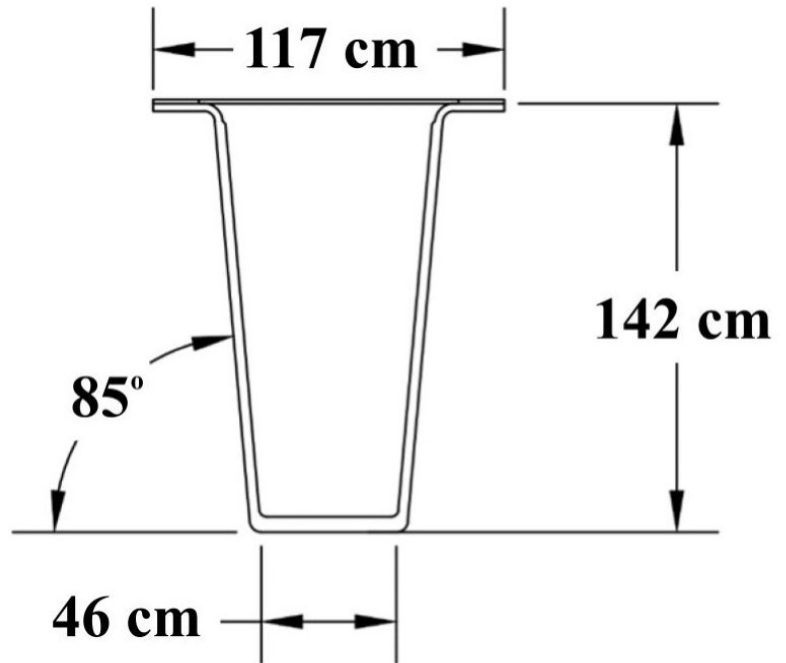

Figure 17: A photo and the dimensions in centimeters (cm) of the FRP or composite tub girder used to form the structure for the design of the wildlife overpass structure on US-97 in Siskiyou County, California (AIT Bridges). *Not drawn to scale*

- (A). AIT composite tub girder
- (B). Precast concrete connector
- (C). FRP anchor
- (D). Longitudinal closure joint
- (E). Cast-in-place concrete deck

- (F). Concrete soil curb
- (G). Perforated drainage pipe
- (H). Drainage aggregate
- (I). Soil
- (J). FRP sound/light barrier

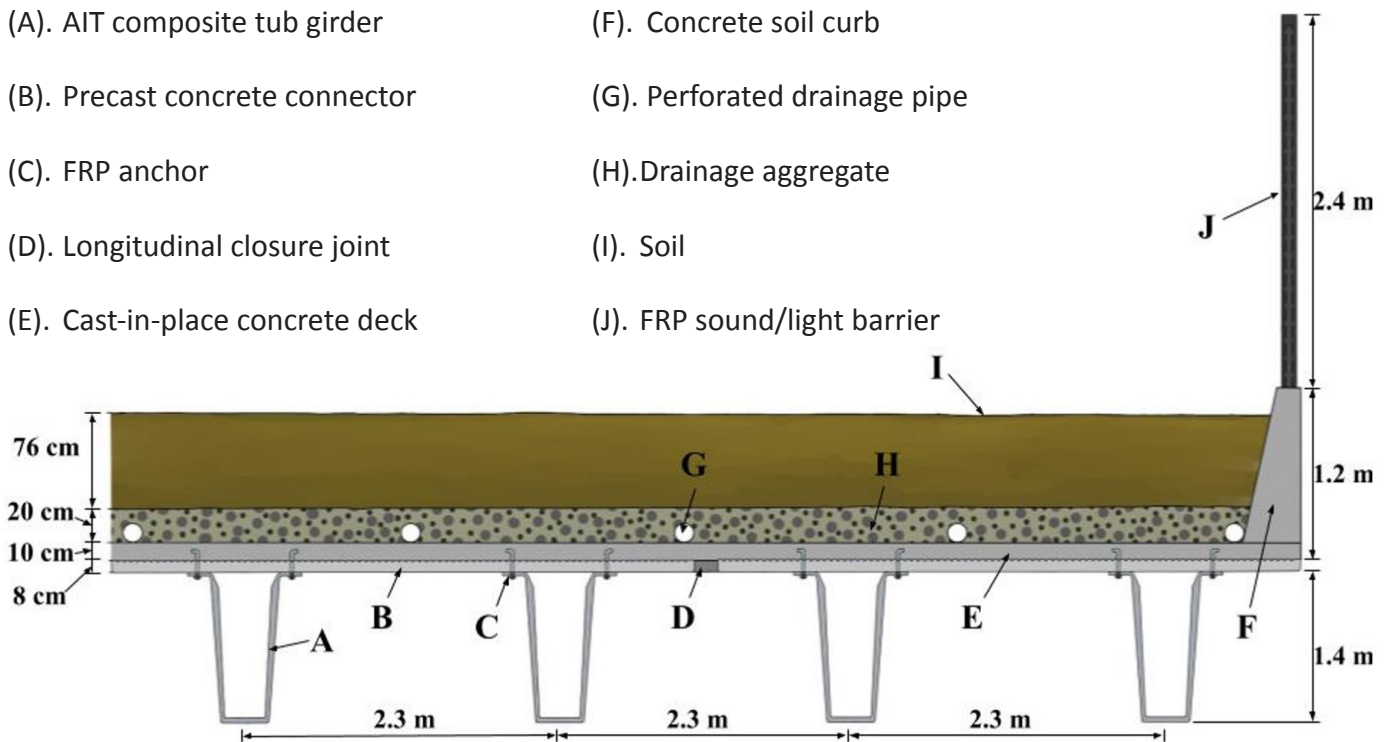

Figure 18: Cross section of the wildlife overpass showing the layout of the girders, concrete deck, soil, drainage, and barriers on the bridge span in meters (m). *Not drawn to scale*



Other Uses of FRP Materials for Crossing Structures

There are many design alternatives for providing an FRP sound and light-retaining barrier along the edges of a wildlife overpass. Variations include cantilevered, hollow-tube posts that attach barrier elements or prefabricated FRP panels directly to the concrete curb in a quick installation. Many of the available products are not labeled or marketed specifically as sound-reducing members so additional investigation into their effectiveness should be pursued. However, the project found that there are commercially available, recycled plastic FRP materials designed for fencing and other non-structural applications, which are recommended for fence posts, jump-out elements, and light and sound barriers.

The study recommended that a simple, recycled plastic FRP light and noise barrier design resembling a traditional wood fence be used

on both sides of the structure on US-97 (Figure 19). After examining recycled plastic board densities from multiple manufacturers, it was determined that FRP boards range from 720-960 kg/m³ (45-60 pounds per cubic foot [pcf]); which is denser than traditional wood fencing. It was predicted that the FRP boards would significantly reduce the sounds of passing vehicles below when compared to a wood fence. They would also eliminate the light of vehicle headlights and running lights from the line-of-sight of animals while they were on the overpass. The barrier design shown in Figure 19 used recycled plastic FRP posts with an I-beam cross-section, which were connected to the top of the soil-retaining concrete curb along the edge of the overpass. The I-shape enabled FRP boards to quickly slide into the horizontal position, held in place by the I-shaped flanges.

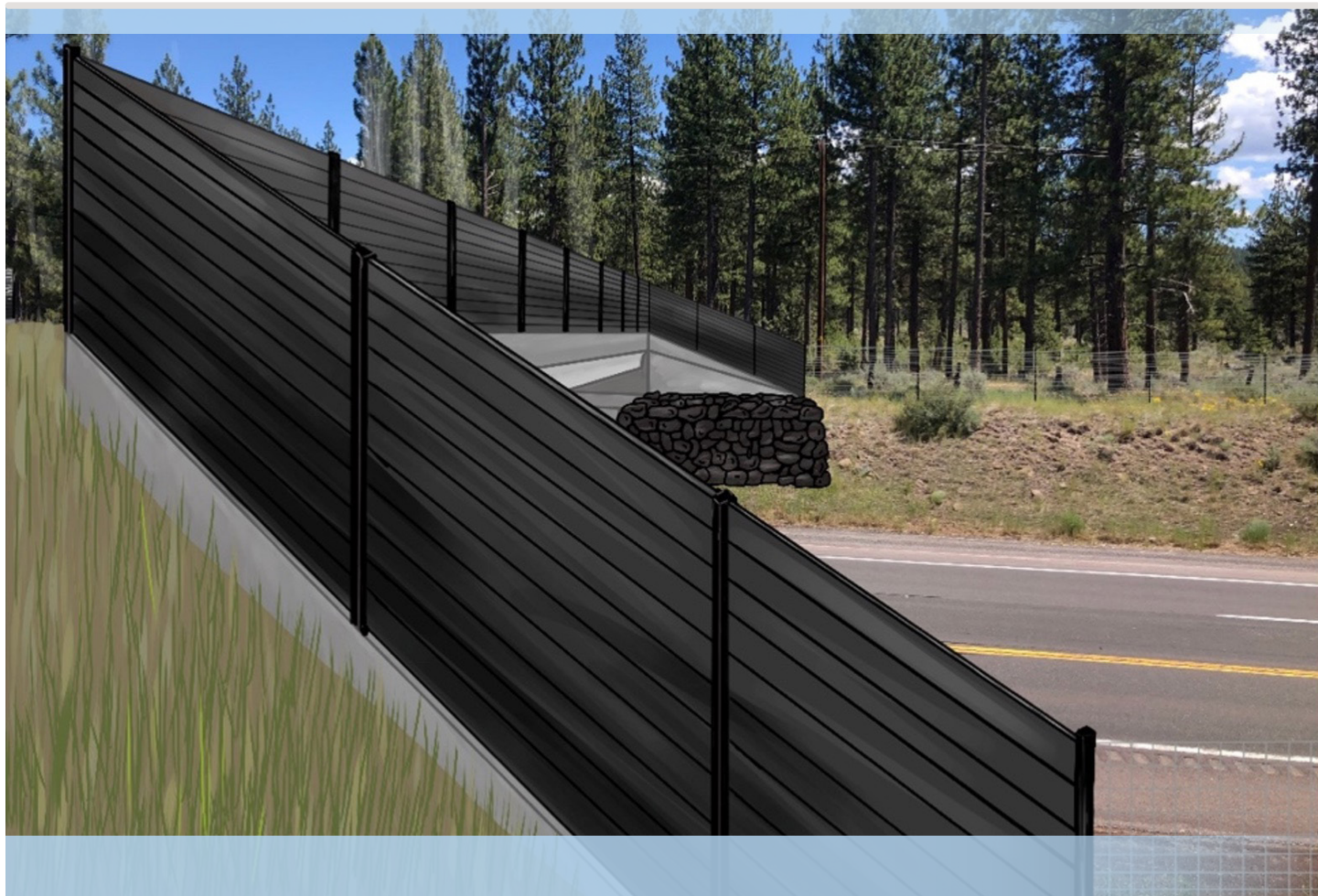

Figure 19: Rendering of a recycled-plastic sound and light barrier installed on top of the FRP overpass on US-97.



Another readily available product using recycled plastics is FRP lumber. For the US 97 site, recycled plastic FRP posts and boards were recommended for the wildlife fencing elements (e.g., fence posts, gates, jump-outs). Wildlife fencing made with FRP materials uses the same construction techniques as conventional steel and wood wire-mesh fences. Fence posts can either be driven into the ground for

straight sections of fencing or placed in a concrete base with bracing for additional support at corners, slope changes, and turns. Recycled plastic boards are recommended for fencing elements because they will last longer than traditional materials, remove landfill waste, and can be recycled if sections of the fence need to be replaced.

Life Cycle Costs of FRP

The project evaluated the use of FRP girders in other research and found that the initial cost of FRP girder bridges may be higher than concrete and steel types, but their life cycle costs are lower due to their durability and assumed reduction in maintenance costs. In other projects, such as a FRP composite tub girder bridge in Florida, the bridge was estimated to cost 40% less than a prestressed concrete girder reinforced with carbon-steel and 14% less than the same prestressed concrete girder with stainless-steel reinforcement. These estimates were calculated using a 100-year service life. In Sweden, a glass FRP wildlife overpass was estimated to cost 49% less than the concrete equivalent, and 21% less than a carbon FRP design over a 120-year service life. A glass-FRP wildlife overpass had maintenance costs estimated to be 50 to 80% less than steel and concrete equivalents.

For the US-97 wildlife overpass design, using the FRP tub girders was estimated to cost 11% more than a prestressed concrete bridge, but 30% less than the steel equivalent. Furthermore, using recycled plastic FRP for wildlife fencing, jump-outs, and road access points along US-97 is estimated to cost 38% less than wood and 28% less than steel over 100 years. An evaluation of the entire mitigation area shows that the use of FRP materials is the most competitive option. Wildlife fencing elements made with wood combined with an overpass made from concrete is estimated to cost \$10,453,856 (in 2019 US dollars [US\$]) over 100 years. Wildlife infrastructure built with recycled plastic FRP and a FRP tub girder overpass structure is estimated to cost \$9,961,309 (2019 US\$), 5% less than wood and concrete. The initial cost of constructing a FRP wildlife crossing may be more expensive than using concrete, steel, and wood, but FRP materials last longer and have lower maintenance costs.

Summary

The preliminary design of an FRP wildlife overpass for a specific crossing location allowed researchers to document an example of a feasible, efficient, and constructible alternative to conventional steel and concrete materials. The benefits of FRP materials were maximized, through their use in the US-97 superstructure, concrete reinforcement, fencing, and light and sound barriers. The final report documents an FRP wildlife overpass that could be implement-

ed by a state DOT with minimal departure from traditional materials and construction techniques while still saving money over the life of the structure.

Link to the final report:

<http://doi.org/10.15788/ndot2022.09>



Research to Inform Passage Spacing for Migratory Amphibians and to Evaluate Efficacy and Designs for Elevated Road Segment (ERS) Passages

Background

Amphibians are known to be particularly susceptible to the negative effects of roads; many move slowly, do not avoid roads and are not avoided by drivers. Narrow tunnels that are underpasses that are less than 1m (39 inches) per side, connected with barrier fencing, are a stan-

dard mitigation solution. However, there is recent evidence to suggest that tunnel mitigation systems compress the migratory movements of species that typically disperse over large areas, and unintentionally cause population decline.

This project sought to determine;

- 1 the distances that the Yosemite toad (*Anaxyrus canorus*) will move along barrier fencing before they “give up” and move back into the habitat and
- 2 the efficacy of a novel road crossing prototype for toads and other small wildlife species.

The Yosemite toad is an endangered species and an endemic toad found only in California.



Figure 20: Male (left) and female (right) Yosemite toad (*Anaxyrus canorus*) (Maierpa, Wikipedia).

The prototype crossing structure was an elevated road segment (ERS) on a US Forest Service Road that was raised 8 in (20.3 cm) above the ground level. It was nearly 100 feet (30.5 m) wide and allowed both light and rain to pass through (Figure 21). It could also be made any length. The project included an assessment by transportation engineers, in collaboration with Caltrans, that provided insight, guidance, and concept designs for similar crossing solu-

tions that could be implemented on high traffic volume roads and highways. The results helped determine the minimum distances required between toad crossings to support population-level movements across roads. It also developed concept plans for a small animal crossing structure design that more effectively provides habitat connectivity and offers an alternative to below-grade tunnels for sensitive amphibians, reptiles, and small mammals.

What Was Learned

On average, Yosemite toads moved 46 m (151 ft) along barrier fencing before “giving up” and their probability of reaching a crossing decreased rapidly with increased distance from

the elevated road segment. Many individual toads moved back and forth along the fencing and approximately 90% of toads were estimated to move 20 m (26 ft) or more along the fence,





Figure 21: Left to right, top to bottom, Yosemite toad (*Anaxyrus canorus*) at a monolithic 5 mm diameter polyethylene fence. Vehicles driving on the Elevated Road Segment (ERS), 3D rendering of an ERS concept design (C Brehme, USGS et al).

with an average distance of 46 m (151 ft). These results suggest that crossing structures spaced within 20 m of one another along Yosemite toad migratory pathways are likely to provide connectivity for up to 90% of the population.

The direction Yosemite toads turned when reaching the barrier fencing had a large influence on whether they reached a crossing. Toads that reached the barrier fencing and then travelled in the wrong direction (away from the passage) were significantly less likely to reach the passage than toads that made the correct initial direction choice.

The average distances moved by Yosemite toads were significantly greater along solid fencing than along mesh fencing (1.8 times greater). These differences were particularly marked for adult toads, whose movement distances averaged 2.7 times greater along the solid fence. This suggests solid fencing may be more effective than mesh if fencing is used for the purpose of leading migrating amphibians and other small animal species to a passage. The authors noted that for non-migratory species, more widely spaced crossings may be

sufficient to enable reproductive and genetic connectivity.

Lastly, the project demonstrated that the ERS has great potential to provide increased connectivity for a wide range of other amphibian, reptile, and small mammal species while greatly reducing road mortality. All small animal species that were detected in the forest habitat were also detected under the ERS structure, except for one species of mole.

As part of the project, an engineering firm produced four ERS concept designs that received engineering evaluations for their use in similar crossing structures on primary roads and highways. This project provided very useful information for the future development of ERS crossings on high traffic roads that impact small animal, reptile, and amphibian populations in other locales.



Link to the final report:

<https://bit.ly/Tpf-5-358>
[WVC_USGS_ERS_Passages](#)



Modified Jump-Outs for White-Tailed Deer and Mule Deer

Background

Although widely deployed throughout North America, there is no standard design guidance for effective “jump-outs” or “escape ramps” by which animals caught on the inside of fenced road corridors can safely exit. There have been designs with various jump-out features, such as a range of wall heights or “faces” of the jump-out (Figure 22), the grade of the approach slopes (Figure 23), and whether to place a perpendicular fence to guide animals to the opening (Figure 23). These heights, slopes, and related design features can vary on the same highway mitigation project.

This project investigated the effectiveness of modifying existing jump-outs on US Highway 93 on the Flathead Reservation in western Montana. Existing jump-outs varied in height between 1.75 and 2.04 m (5.7-6.7 ft).

Between 2008 and 2015, the 52 jump-outs in the study area were monitored using tracking

beds^{*1} on top and bottom of the jump-outs (Huijser et al. 2016). As part of this long-term study, more detailed monitoring with wildlife cameras evaluated ten of the jump-outs over three years. It determined that only 6.88% of the white-tailed deer and 32.35% of the mule deer detected on the top of the jump-outs jumped down to the safe side of the fence (Huijser et al. 2016). None of the deer that passed by on the outside of exclusionary fencing were captured jumping up into the fenced road corridor via the jump-outs (Huijser et al. 2016).

As part of the new study, most of the ten jump-outs monitored with cameras were lowered to 1.5 m (5 ft) and provided with a top bar that varied in height and setback (i.e., distance to the face of the jump-out). The researchers investigated the potential increase in desired use (i.e., jumping down) and undesired use (i.e., jumping up) for white-tailed deer and mule deer with different configurations of the bar.



Figure 22: A view of a jump-out from outside the exclusionary fencing. The concrete block wall is designed to be high enough to dissuade animals from entering the roadway corridor, yet low enough for animals inside to jump to the outside of the fenced roadway corridor (Marcel Huijser).

^{*1}Tracking beds are soft sand areas that are monitored on a regular basis to count what species used them and what direction the animal was headed (jumping up and inside the fencing toward the highway or jumping down and out of the fencing and away from the road). After each monitoring event, they are raked smooth to capture future animal use.



Figure 23: A view of a jump-out on the highway side of the fencing with a perpendicular fence that is designed to direct animals following the exclusionary fence to use the jump out (Marcel Huijser).

What Was Learned

The modified jump-outs (see Figure 24 for an example) nearly doubled the effectiveness in allowing mule deer to escape the fenced road corridor. However, there was no improvement for white-tailed deer and further investigation into modifications of the bar, with a lower height and greater setback, are warranted. It may be that a jump-out height of 1.5 m (5 ft) is too high for white-tailed deer, regardless of the presence, height, and setback of a bar.



Link to final report

<http://doi.org/10.15788/ndot2018.2022>



Figure 24: A jump-out that is modified with a 2 in (5 cm) by 2 in (5 cm) bar for the design experiment (Marcel Huijser).



Internal Structural Cover and Ledges Facilitate the Use of Large Underpasses for Multiple Wildlife Species and Groups

Background

To date, most studies that evaluate the effectiveness of large underpasses designed to offer animals safe passage across highways have focused on large animal movements, primarily the carnivores and ungulates which were the focus of the structural designs. The many other, often smaller, and less mobile species that might make use of the same overpass or underpass structures are often not evaluated. Often, design guidance recommends the incorporation of structural elements that provide more complex underpass habitat for these smaller or less mobile species, although this is often unsupported by evidence. Consequently, more studies are needed to determine the effectiveness of the design features that support the needs of these other species.

A US Geographic Survey (USGS) team set about to complete a two-year BACI field study on eight large upland wildlife underpasses in San Diego County, California. The objectives of this study were to determine;

- 1 if small vertebrate species are using these underpasses,
- 2 if ledges and the addition of structural elements (concrete block piles 5 m (16.4 ft) apart along one side of a structure) within underpasses facilitate small animal movement, and
- 3 if the addition of these structural elements (piles of blocks) might adversely affect the use rates of medium- and large-bodied mammals.



Figure 25: Clockwise: concrete underpass, internal structure/cover treatments, Granite spiny lizard (*Sceloporus orcutti*), California king snake (*Lampropeltis californiae*), and Rat (*Rattus*), (Photos: Cheryl Brehme and Robert Fisher, USGS).



The USGS team selected a BACI design to investigate whether adding structures to the eight large underpasses improved small vertebrate use. A pre-treatment sampling period was conducted to establish baseline conditions and relative activity of species and species groups within and outside the underpasses. Then the treatment was applied to half of the underpasses and a second sampling was taken.

What Was Learned

There were a variety of small wildlife responses to the addition of cinder block piles along one side of each of the treated underpasses. The authors surmised that the increase in predators, such as coyote (*Canis latrans*), may have been due to the increase in prey using the cinder block piles as cover, and that the decline in bobcats (*Lynx rufus*) and skunks (*Mephitis mephitis*) may have been due to their known avoidance of coyote, whose use of the underpasses increased. Deer (*Odocoileus spp.*) use did not change, which appears to demonstrate

Animal use was monitored by deploying motion detection cameras.

The results of this study will help inform the design of future large underpasses so that they can effectively support large mammals as well as a variety of other smaller species from nearby wildlife communities.

that the cinder block piles did not create a barrier effect for the target species for which the underpasses were designed. The application of piles of cinder blocks on one side of the treated underpasses provided strong evidence that providing cover increases use by a variety of species, particularly prey species that may typically avoid large open underpasses. The study found that a few species may not benefit due to predator-prey relationships, and others may not be affected at all by such treatment.

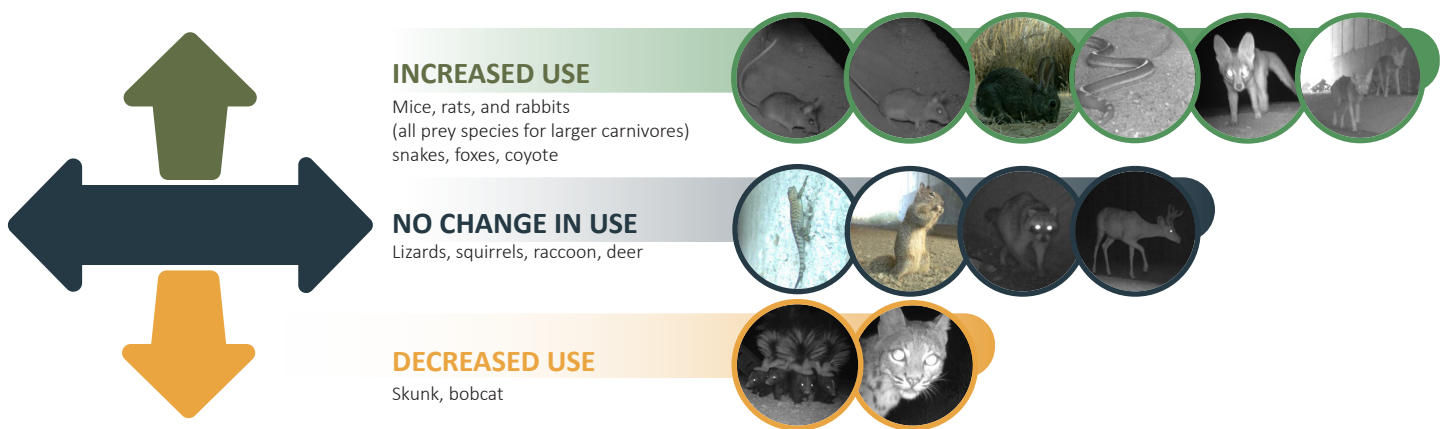
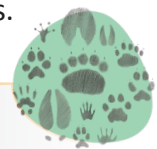

Figure 26: Summary of changes in underpass use by various species after the installation of internal structure/cover treatments.

The monitoring and evaluation of the ledges in the large open underpasses, to which there were no on or off ramps, revealed extensive use by mice. The mice would use a ledge ten times more than the area outside the underpass and five times more than the floor of the underpass. However, the ledges were used much less frequently by rats and lizards. The authors surmised that the ledges were used as both a hunting perch by several of the small

species and as a safe haven by mice. It was recommended, based on the amount of use by the various small species, that ledges with ramps be added to large overpass structures as standard practice in future designs.

Link to the final report:
https://bit.ly/Tpf-5-358_WVC_USGS_Underpass_Internal_Structural_Cover



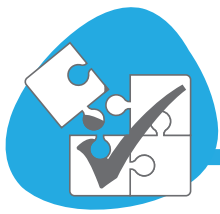

BEST PRACTICES

The variety of research projects and the literature review conducted for the TPF Study has contributed to an updated body of knowledge regarding the effectiveness of WVC mitigation measures and their ability to provide for habitat connectivity. The TPF Study also offers new options, designs, and best practices. This provided an opportunity to develop a Manual that focusses on those mitigation measures that were found to be successful as well as cost effective. Best management prac-

tices, the selection of countermeasures, design criteria, fence elements such as jump-outs, vehicle and pedestrian access, product guidance, and species-specific designs have all been incorporated into the Manual. The addition of new technologies for animal identification – drive warning systems, maintenance concerns, and cost-benefit analyses can all provide guidance for the implementation of mitigation measures across North America’s broad range of species, environments, and habitats.

Best Practices Manual to Reduce Animal-Vehicle Collisions and Provide Habitat Connectivity for Wildlife

Manual Structure

The Best Practices Manual (Manual) provides practical information for the implementation of mitigation measures designed to:

1 *improve human safety through reduced collisions with large animals, including large wild mammal species, select free-roaming large feral species, and select free-roaming large livestock species; and,*

2 *improve or maintain habitat connectivity for terrestrial wildlife species and selected feral species through safe crossing opportunities.*

The Manual focuses on three main species groups:

section A

relates to large wild mammals,

section B

addresses large livestock and feral animals,

section C

focuses on small wildlife species.

The recommended mitigation measures for each of the three species groups are then described.

The Manual does not include all possible measures that can or may reduce AVCs and maintain or improve habitat connectivity for wildlife. It is presumed that roads will not be permanently or temporarily closed, and that

traffic will not be forcibly reduced or halted. In addition, culling, relocating and anti-fertility treatments were not considered acceptable mitigation measures for livestock, but could be considered for large feral mammals.



Summary of Recommended Measures

Large Wild Mammals

The term Large Wild Mammals refers to North American wild mammal species that have a body size and weight larger than a coyote (*Canis latrans*).

Barriers (fences) in combination with crossing structures are recommended as the most effective of the mitigation measures.

The Manual highlights considerations for planning and design that include fence end treatments, access roads, and jump-outs or escape ramps. Guidance is provided for implementation, construction, operations, and maintenance.



Figure 27: Typical large ungulate fence in North America, 8 ft tall, wooden posts and mesh-wire fence material, US Hwy 93 North, Montana, USA. Note that there is a dig barrier attached to the main fence material (e.g. for canids) (Marcel Huijser).

Large Domesticated Species

Large domesticated species are divided into free roaming livestock and feral (escaped from domestication) horses and burros (donkeys). In many places in the western U.S. there are vast areas of open range (no fences) on both public and private lands. In open range areas, livestock are not required to be contained and are free to move across the landscape, including roads. In some cases, it is appropriate to simply install right-of-way fencing to keep livestock from accessing the road corridor, while in other cases livestock may need to be able to be able to move freely across the road to access resources such as forage and water. In these cases, fencing must connect to suitable crossing structures. When designing mitigation measures for livestock, it is imperative to consider the wildlife in the area. Measures aimed at reducing collisions with livestock should not come at the expense of wildlife. In some cases, concentrations of livestock-vehicle collisions may coincide with concentrations of WVCs,

though this is often not the case (Creech et al. 2019). In locations where livestock- and wildlife-vehicle collisions occur in the same locations, the mitigation measures for large wildlife species can effectively reduce collisions and provide connectivity for both wild and domestic species.

Despite only representing a small proportion of all AVCs nationwide, collisions with livestock can be locally abundant. Some states experience higher rates of collisions with livestock than others; 15% and 16% of the reported AVCs in California and Utah, respectively (Perrin & Disegni 2003; Huijser et al. 2008) and collisions with livestock can account for a significant portion of all AVCs and their associated human safety risks in some rural areas (Creech et al. 2019). Rural roads with high design speeds, high speed limits, and no artificial lighting present the highest risk for human fatalities associated with AVCs.



Collisions with livestock such as cattle and horses are much more dangerous on a per-collision basis than collisions with wildlife, as the most abundant wild large mammal species in crash and carcass databases are much smaller and lighter (e.g., deer (*Odocoileus spp.*) (Cramer & McGinty 2018; Creech et al. 2019). In Montana, livestock collisions are three times as likely to result in a human fatality than collisions with wild species, and 1.5 times more likely to result in an incapacitating human injury (Creech et al. 2019). Similarly, studies in Utah, Nevada, and Texas have also found that livestock collisions are more likely to result in human injury or death than the average collision with a wild species

AVC mitigation measures for free roaming livestock include roadside animal detection – driver warning systems, physical barriers (fencing) and fences in combination with crossing structures.

Feral horse-vehicle and burro-vehicle collisions are a considerable and increasing problem in certain areas (Cramer & McGinty 2018; Gagnon et al. 2022) as feral horse and burro popu-

lations have been steadily increasing on western U.S. public rangelands (Scasta et al. 2018). Collisions with feral large mammals can be locally common, can be a substantial concern for human safety, and may require measures to reduce these collisions (Creech et al. 2019). The literature on research and best practice management for feral large mammals is limited (Boyce et al. 2021), particularly relating to interactions with roads (Gagnon et al. 2022).

The most effective collision mitigation measures for feral horses and burros detailed in the Manual include culling, relocation, anti-fertility treatment, roadside animal detection systems, virtual fencing, physical fences, fences in combination with crossing structures, access points, and fence ends.

The most effective collision mitigation measures for feral horses and burros detailed in the Manual include culling, relocation, anti-fertility treatment, roadside animal detection systems, virtual fencing, physical fences, fences in combination with crossing structures, access points, and fence ends.



Figure 28: Wildlife friendly livestock fence with smooth top and bottom wires, Montana, USA (Marcel Huijser).

Small Wildlife Species

Small wildlife species include small wild mammal species (no minimum size for the species, but maximum size approximates a coyote), wild reptile species, and wild amphibian species in North America that are fully or predominantly terrestrial. This excludes flying species and arboreal species, as well as invertebrates.

As a rule, barriers for small wild animal species should be combined with crossing structures and the combination should be regarded as a package. For high volume roads and roads that cannot be closed or removed, the combination of barriers and crossing structures is the most

robust and effective way to reduce direct road mortality for small animal species, while also allowing the animals to cross safely to the other side of a road. While crossing structures as a stand-alone measure can provide connectivity, they need to be combined with fences or other barriers to reduce direct road mortality. If there are multiple target species with different habitat requirements, multiple structures that accommodate different species requirements may be required (Table 8). Alternatively, larger structures that accommodate multiple habitat types and environmental conditions can help address this issue.

Table 8: Suitability of different types of mitigation measures for selected small and medium sized mammal species.

| | Wildlife overpass | Open span bridge | Large mammal underpass | Medium mammal underpass | Small-medium mammal pipes |
|-----------|-------------------|------------------|------------------------|-------------------------|---------------------------|
| Badger | ● | ● | ● | ● | ● |
| Beaver | ⊙ | ● | ● | ? | ? |
| Fisher | ● | ● | ⊙ | ⊙ | ⊙ |
| Grey fox | ● | ● | ● | ● | ● |
| Opossum | ● | ● | ● | ● | ● |
| Porcupine | ● | ● | ● | ? | ⊗ |
| Raccoon | ● | ● | ● | ● | ? |
| Red fox | ● | ● | ● | ● | ● |
| Ringtail | ● | ● | ● | ⊙ | ⊙ |
| Skunks | ● | ● | ● | ● | ? |
| Squirrels | ● | ● | ● | ⊗ | ⊗ |
| Wolverine | ● | ● | ? | ? | ⊗ |

Key: ● Suitable ⊙ Likely suitable ⊗ Not suitable ? Unknown/unsure if suitable

The Manual provides guidance for planning and design, barrier considerations, and enhancing existing structures for small wildlife. Implementation, construction, operation, and maintenance practices are placed in the following three categories:

- 1 Fences and Other Barriers,
- 2 Wildlife Crossing Structures, and
- 3 Jump-outs or Escape Ramps.

Link to the Manual:

<http://doi.org/10.15788/ndot2022.2>



CONCLUSIONS

This Transportation Pooled Fund Study, TPF-5(358), was a cooperative international effort of nine state departments of transportation, a Canadian provincial ministry of transportation, Parks Canada Agency, a non-governmental organization, ARC Solutions, all acting in concert with the US Department of Transportation's Federal Highway Administration. Combining over \$1 million in resources allowed Task 1 of the TPF Study to conduct a literature review, three economic studies, and eight scientific research projects. It also produced a Best Practices Manual and a final report.

LITERATURE REVIEW

Researchers conducted a literature review to evaluate the latest information on the effectiveness of 24 different highway mitigation measures designed to decrease collisions with large wildlife, large domestic animals, and small mammals, reptiles, and amphibians. It explored the effectiveness of these same measures to maintain or enhance habitat connectivity. The results of the literature review indicate only nine measures achieved at least a 50% reduction in WVCs and of these, only two – overpasses and/or underpasses, or overpasses and/or underpasses with fencing – maintained or increased habitat connectivity.

The ten mitigation measures that were found to achieve at least a 50% reduction in WVCs were: night-time lighting, roadside animal detection systems, seasonally deployed wildlife warning signs, seasonal road closures, wildlife culling, wildlife relocation, fencing (although it reduces habitat connectivity), wildlife crossings alone (highly variable), underpasses/overpasses with fencing. The last measure was found to be highly effective at both reducing WVCs and the barrier effect of roads and traffic.

ECONOMICS

The TPF Study conducted three different economic studies, they updated and added new values to the cost-benefit analyses of WVC mitigation measures and synthesized and developed new passive use values for species of interest due to their mortality on North American highways. Although the passive use value studies did not cover all of North America's common species, economic values were described for deer, elk, wolves, grizzly bear, turtles, and Mojave desert tortoises of the southwest US. Individual passive use values (US 2020 dollars) of these species ranged from over three thousand US dollars for an individual turtle, \$5,075 for a deer, \$27,751 for an elk and more than \$4 million per grizzly bear.

The final economic study developed a cost benefit analysis of WVC mitigation measures with new calculations for the direct costs of crashes with large wildlife species and domestic animals. It compared the cost of preventing those AVCs with the costs of implementing mitigation measures and maintaining them over their service life. The average cost per crash in 2020 US dollars (\$) was for deer (\$19,089), elk (\$73,196), moose (\$110,397), cattle and horses (\$82,646). These figures were significantly higher, more than three-fold, than in a journal article published by many of the same authors in 2009.



ECOLOGY

A group of the research projects evaluated various facets of the ecological consequences of highway mitigation measures designed to reduce WVCs. One study provided novel and rare details on the links between road mortalities and the demographic structure of an adjacent elk population. Another used nearly two decades of data to evaluate the species-specific use of wildlife crossings and explore the long-term effects of crossing design types, adjacent habitat, and other factors that best explain species variation in crossing use.

A third research project found that wildlife exclusionary fencing created declines in WVCs for common ungulates - elk, mule deer, and

white-tailed deer - by up to 96%, although reductions for large carnivores were much lower. It was estimated that in a ten-year period, the fencing would provide a net economic gain of more than \$500,000 per kilometer, due to reduced ungulate-vehicle collisions. The last ecological study experimented with five different electrified barriers that can be used at the intersections of low volume access roads and the highway or at fence ends. Four of the five electric barriers tested created nearly a complete barrier to black bears, the subject of the electrified barrier study. The project also found that two cattle or wildlife guards set side by side (4.6-6.6 m (15-22 ft) wide) are best for ungulates.

DESIGN

The final four research projects explored new designs for WVC mitigation measures and improved habitat connectivity. The first developed a design that used Fiber Reinforced Polymer (FRP) materials to replace traditional steel, concrete, and wood in a wildlife overpass crossing. A wildlife crossing employing a FRP tub girder overpass structure and recycled plastic FRP posts and boards for fencing, sound barriers, gates and jump-outs was estimated to cost \$9,961,309 (2019 US\$) for the US 97 site, 5% less than a concrete structure with wood fencing and jump-outs.

The next design project evaluated the efficacy and success of a novel road crossing prototype for toads and other small wildlife species, referred to as an elevated road segment (ERS), and included four new ERS designs for high volume roads. All small animal species that were detected in the adjacent forest habitat were also detected under the ERS structure, except

for one species of mole.

The third experiment designed jump-outs which allow animals caught on the inside of fenced road corridors to safely exit. The experiment's modified jump-outs nearly doubled the effectiveness in allowing mule deer to escape the fenced road corridor; but, had little effect on white-tail deer. The last experiment added piles of cinder blocks along one side of large, open underpasses designed for deer to facilitate the movement of smaller species. Mice, rats, and rabbits (all prey species for larger carnivores) as well as snakes, foxes, and coyote all increased their use in the underpasses tested, while creating no impediment for deer use. The underpasses also had low ledges along the sides of the structures. It was determined that mice used a ledge five times more often than the underpass floor and ten times more often than outside the underpass, indicating ledges are considered a safe haven for these species.

MANUAL

The TPF Study also produced a Manual of Best Practices that offers the best available information to practitioners that seek to employ the

effective mitigation measures to reduce WVCs and those that improve habitat connectivity.



REFERENCES

- Amuakwa-Mensah F, R Bärenbold, and O Riemer. 2018. Deriving a Benefit Transfer Function for Threatened and Endangered Species in Interaction with Their Level of Charisma. *Environments*, 5:31.
- Bell M, Fick D, Ament R, Lister N-M. 2020. The use of fiber-reinforced polymers in wildlife crossing infrastructure. *Sustainability*, MDPI, Open Access Journal, vol. 12(4), pages 1-15, February.
- Boyce PN, Hennig JD, Brook RK, McLoughlin PD. 2021. Causes and consequences of lags in basic and applied research into feral wildlife ecology: the case for feral horses. *Basic and Applied Ecology*, 53, 154-163.
- Brehme, C., Barnes, S., Ewing, B., Vaughan, C., Hobbs, M., Tornaci C., Gould, P, Holm S. Sheldon, R. Fisher. 2022. Research to inform passage spacing for migratory amphibians and to evaluate efficacy and designs for open elevated road passages. USGS Cooperator Report to Nevada Department of Transportation, Transportation Pooled Fund Program Project P342-20-803.
- Cramer P, McGinty C. 2018. Prioritization of wildlife-vehicle conflict in Nevada. Nevada Department of Transportation, Carson City, NV.
- Creech TG, Fairbank ER, Clevenger AP, Ament RJ. 2019. Differences in spatiotemporal patterns of vehicle collisions with wildlife and livestock. *Environmental Management*, 64, 736-745.
- Duffield, J. 1991. Existence and non-consumptive values for wildlife: Application to wolf recovery in Yellowstone National Park. Pages 1-1-1-39 in C. L. Kling, ed., *Benefits and costs in natural resource planning*, Fourth Interim Rept., Univ. California, Davis. 380 pp.
- Duffield, J, Neher, C, and D Patterson. 2006. *Wolves and people in Yellowstone: Impacts on the regional economy*. Report for the Yellowstone Park Foundation. Bozeman, MT. 67 pp.
- Duffield J, Neher C. 2019. Incorporating wildlife passive use values in collision mitigation benefit-cost calculations. Report No. 701-18-80 TO 1, Nevada Department of Transportation, Carson City, NV. 58 pp.
- Duffield J, Neher C. 2021. Incorporating deer and turtle total value in collision mitigation benefit-cost calculations. Report 701-18-803 TO 5, Nevada Department of Transportation, Carson City, NV. 62 pp.
- Edwards V. 2017. An Overview of State fish and wildlife agency restitution programs for illegally taken big game species. Prepared for: Boone and Crockett Club and Leupold & Stevens. Online at: <https://prod-boone-crockett.s3.amazonaws.com/s3fs-public/atoms/files/poachandpayfinalreport.pdf> [accessed 14 July 2022].
- Ford AT, Barrueto M, Clevenger AP. 2017. Road mitigation is a demographic filter for grizzly bears. *Wildlife Society Bulletin* 41:712–719. Wiley Online Library.
- Gagnon JW, Beach CA, Sprague SC, Nelson HP, Loberger CD. 2022. Strategies to reduce burro-vehicle collisions in the Lake Pheasant Area. Report No. FHWA-AZ-22-753, Arizona Department of Transportation, Phoenix, AZ.



- Huijser, M.P., P. McGowen, J. Fuller, A. Hardy, A. Kociolek, A.P. Clevenger, D. Smith, and R. Ament. 2007. Wildlife-vehicle collision reduction study. Report to Congress. U.S. Department of Transportation, Federal Highway Administration, Washington D.C., USA.
- Huijser, M.P., P. McGowen, A. P. Clevenger, & R. Ament. 2008. Best practices manual, wildlife-vehicle collision reduction study, Report to U.S. Congress. Federal Highway Administration, McLean, VA, USA.
- Huijser, M.P., Duffield, J.W., Clevenger, A.P., Ament, R.J., and P. T. McGowen. 2009. Cost-benefit analyses of mitigation measures aimed at reducing collisions with large ungulates in North America; a decision support tool. *Ecology and Society*, 14 (2):15.
- Huijser MP, Fairbank ER, Camel-Means W, Graham J, Watson V, Basting P, Becker D. 2016. Effectiveness of short sections of wildlife fencing and crossing structures along highways in reducing wildlife-vehicle collisions and providing safe crossing opportunities for large mammals. *Biological Conservation*, 197: 61–68. doi.org/10.1016/j.biocon.2016.02.002
- Huijser MP, Ament RJ, Bell M, Clevenger AP, Fairbank ER, Gunson KE, McGuire T. 2021. Animal vehicle collision reduction and habitat connectivity pooled fund study – Literature review. Report No.701-18-803 TO1. Nevada Department of Transportation, Carson City, NV.
- Olson DD, Bissonette JA, Cramer PC, Bunnell KD, Coster DC, Jackson PJ. 2014. Vehicle collisions cause differential age and sex-specific mortality in mule deer. *Advances in Ecology* 2014.
- Perrin J, Disegni R. 2003. Safety Benefits of UDOT Highway Program, Animal-Vehicle. Accident Analysis. Salt Lake City, Utah DOT.
- Public Law 109-59. 2005. Safe, Accountable, Flexible, Efficient Transportation Equity Act. Online at: <https://www.fhwa.dot.gov/safetealu/legis.htm> [accessed 30 September 2022].
- Ramp D, Caldwell J, Edwards KA, Warton D, Croft DB. 2005. Modelling of wildlife fatality hotspots along the snowy mountain highway in New South Wales, Australia. *Biological Conservation* 126:474–490.
- Scasta JD, Henning JD, Beck JL. 2018. Framing contemporary U.S. wild horse and burro management processes in a dynamic ecological sociological and political environment. *Human-Wildlife Interactions* 12(1): 31-45.
- USDOT (U.S. Department of Transportation). 2021. Memorandum to secretarial officers and modal administrators. Guidance on the treatment of the economic value of a statistical life (VSL) in U.S. Department of Transportation Analyses – 2021, Update.
- U.S. Fish and Wildlife Service. 2000. Grizzly bear recovery in the Bitterroot Ecosystem. Final Environmental Impact Statement. Missoula, MT.



LIST OF FIGURES

Figure 1: Herd of elk crossing a rural roadway in the Yellowstone River valley of Montana. (Renee Callahan, ARC Solutions). 9

Figure 2: Summary of the TPF Study Final Report’s four themes and their associated projects. 10

Figure 3: The five-phase process used for Task 1 of the TPF-5(358) Study. 11

Figure 4: A representation of species described with passive use values in the cost benefit analysis. Clockwise: Mojave desert tortoise (*Gopherus agassizii*) (Elizabeth Fairbank, CLLC), White-tailed deer (*Odocoileus virginianus*) (N Hetherington, WTI/MSU), Wolf (*Canis lupus*) (Jim Peako, NPS), and Elk (*Cervus elaphus*) (N Hetherington WTI/MSU). 12

Figure 5: A variety of large and small wild animal species, free ranging livestock, and feral horses and donkeys are addressed in the Literature Review. Red squirrel (*Sciurus vulgaris*) N Hetherington, WTI/MSU), Wild horses (*Equus ferus*) (Dreamstime), Painted turtle (*Chrysemys picta*) (C M Highsmith), Coyote (*Canis latrans*) (N Hetherington WTI/MSU), Moose (*Alces alces*) (Jim Peako, NPS), Bull snake (*Pituophis catenifer sayi*)(J W Frank, NPS), Elk (*Cervus canadensis*) (N Hetherington WTI/MSU), Pika (*Ochotona princeps*) (J Waller, NPS), Pine marten (*Martes americana*) (J W Frank, NPS), Holstein cow (*Bos taurus*) (Adobe stock), Tiger salamander (*Ambystoma tigrinum*) (N Herbert, NPS), Wolf (*Canis lupus*) (Jim Peako, NPS), Mojave desert tortoise (*Gopherus agassizii*) (F Deffner, USFWS), Bobcat (*Lynx rufus*) (Neal Herbert, NPS). 14

Figure 6: Left: Mule deer (*Odocoileus hemionus*) on US95 overpass (NDOT). Right: Horses using underpass (NDOT). 17

Figure 7: A representation of the wildlife included in the cost benefit analysis – clockwise, Elk (*Cervus elaphus*) (N Hetherington WTI/MSU), Grizzly bear cubs (*Ursus arctos horribilis*) (NPS), Wolf (*Canis lupus*) (Jim Peaco, NPS), and Mojave desert tortoise (*Gopherus agassizii*) (Flo Deffner, USFWS). 19

Figure 8: Species of interest in the Minnesota study. Clockwise: Blandings turtle (*Emydoidea blandingii*) (Andrew Cannizzaro) and White-tail deer (*Odocoileus virginianus*) (N Hetherington, WTI/MSU), public information sign, (Christopher Smith, MnDOT). 21

Figure 9: Key findings from the Minnesota household survey. 22

Figure 10: A sampling of animals used in the project to estimate cost of the average collision. Elk (*Cervus elaphus*) (Jacob W Frank, NPS), Grizzly bear (*Ursus arctos horribilis*) (N Hetherington, WTI/MSU), Wolf (*Canis lupus*) (Jacob W Frank, NPS), Wild horses (*Equus ferus*) (NDOT), and domestic cattle (*Bos taurus*) (N Hetherington WTI/MSU). 23

Figure 11: Location of study area and highways used to examine elk-vehicle collisions in the Central Canadian Rocky Mountains (TCH is Highway 1, the TransCanada Highway). 29

Figure 12: Elk crossing a congested roadway. (Shutterstock) 30

Figure 13: The five different types of crossing structure designs that were evaluated (Tony Clevenger, Overpass Adobe Stock). 31



Figure 14: Common ungulates and large carnivores on, or near, roadways. Clockwise, Pronghorn (*Antilocapra americana*) (Shutterstock), Mule deer (*Odocoileus hemionus*) (iStock - N Hetherington, WTI/MSU) Elk (*Cervus elaphus*) (N Hetherington, WTI/MSU), Black bear (*Ursus americanus*) (Shutterstock) and, Mountain lion (*Puma concolor*) (iStock). 33

Figure 15: An example of an electrified barrier at a fence-end. (Marcel Huijser) 34

Figure 16: Elevation view of the US-97 wildlife overpass. Not Drawn to scale 36

Figure 17: A photo and the dimensions in centimeters (cm) of the FRP or composite tub girder used to form the structure for the design of the wildlife overpass structure on US-97 in Siskiyou County, California (AIT Bridges). Not drawn to scale 37

Figure 18: Cross section of the wildlife overpass showing the layout of the girders, concrete deck, soil, drainage, and barriers on the bridge span in meters (m). Not drawn to scale 37

Figure 19: Rendering of a recycled-plastic sound and light barrier installed on top of the FRP overpass on US-97. 38

Figure 20: Male (left) and female (right) Yosemite toad (*Anaxyrus canorus*) (Maierpa, Wikipedia). 40

Figure 21: Left to right, top to bottom, Yosemite toad (*Anaxyrus canorus*) at a monolithic 5 mm diameter polyethylene fence. Vehicles driving on the Elevated Road Segment (ERS), 3D rendering of an ERS concept design (C Brehme, USGS et al). 41

Figure 22: A view of a jump-out from outside the exclusionary fencing. The concrete block wall is designed to be high enough to dissuade animals from entering the roadway corridor, yet low enough for animals inside to jump to the outside of the fenced roadway corridor (Marcel Huijser). 42

Figure 23: A view of a jump-out on the highway side of the fencing with a perpendicular fence that is designed to direct animals following the exclusionary fence to use the jump out (Marcel Huijser). 43

Figure 24: A jump-out that is modified with a 2 in (5 cm) by 2 in (5 cm) bar for the design experiment (Marcel Huijser).43

Figure 25: Clockwise: concrete underpass, internal structure/cover treatments, Granite spiny lizard (*Sceloporus orcutti*), California king snake (*Lampropeltis californiae*), and Rat (*Rattus*), (Photos: Cheryl Brehme and Robert Fisher, USGS). 44

Figure 26: Summary of changes in underpass use by various species after the installation of internal structure/cover treatments. 45

Figure 27: Typical large ungulate fence in North America, 8 ft tall, wooden posts and mesh-wire fence material, US Hwy 93 North, Montana, USA. Note that there is a dig barrier attached to the main fence material (e.g. for canids) (Marcel Huijser). 47

Figure 28: Wildlife friendly livestock fence with smooth top and bottom wires, Montana, USA (Marcel Huijser). 48



LIST OF TABLES

Table 1: Distinctions between crash terms 11

Table 2: Summary of the ten most effective of the 24 mitigation measures reviewed in the literature review report; they had to achieve at least a 50% reduction in AVCs with large mammals. Each measure was evaluated to determine if it reduced the barrier effect of roads to wildlife movement. Green signifies highly effective, yellow indicates moderately effective and red signifies ineffective. 14

Table 3: Estimated per-animal values, by species. 18

Table 4: Vehicle repair costs, average human injury costs and average human fatality costs per collision for deer, elk, and moose in 2007 and 2020. 22

Table 5: Summary of wildlife values and avoided collision costs in (2020 US dollars (\$)) from both economic studies in the TPF that can be used for cost-benefit analyses (CBAs) of wildlife-vehicle collision (WVC) mitigation measures. 23

Table 6: Total costs associated with large wild wildlife-vehicle collisions (in 2020 US dollars (\$)). 24

Table 7: Threshold values (in US dollars or crash rates) indicate when the costs of crashes involving three common ungulate species in North American are equal to the cost of the construction and maintenance of the mitigation measure. Four different types of mitigation measures are calculated. For the US dollar threshold values, a three percent discount rate*1 was used. 24

Table 8: Suitability of different types of mitigation measures for selected small and medium sized mammal species. 47

